

fx-570CW

fx-991CW

User's Guide

CASIO Worldwide Education Website

<https://edu.casio.com>

Manuals are available in multi languages at

<https://world.casio.com/manual/calc/>

Table of Contents

Before Using the Calculator	5
Read This First	5
About This Manual	5
Key Operations	5
Menu Operations	6
Ⓚ Key and ⓧ Key	7
Examples	7
Initializing the Calculator	7
Calculator "Get Started" Screen	7
Precautions	8
Safety Precautions	8
Handling Precautions	10
Getting Started	10
Attaching and Removing the Front Cover	10
Turning Power On and Off	12
HOME Screen	13
Adjusting Display Contrast	13
Key Markings	13
Indicators	14
Using Menus	15
Calculator Apps and Menus	17
Calculator Apps	17
Selecting a Calculator App	17
Installed Calculator App List	17
Using the SETTINGS Menu	19
Changing Calculator Settings	19
Items and Available Setting Options	20
Using the CATALOG Menu	25
Using the TOOLS Menu	25
Inputting Expressions and Values	27
Basic Input Rules	27
Inputting an Expression Using Natural Textbook Format (MathI/MathO or MathI/DecimalO Only)	28
Undo Operations	29
Using Values and Expressions as Arguments	29
Overwrite Input Mode (LineI/LineO or LineI/DecimalO Only)	29
Basic Calculations	30
Arithmetic Calculations	30
Fraction Calculations	30
Powers, Power Roots, and Reciprocals	32

Pi, Natural Logarithm Base e	34
Pi	34
Natural Logarithm Base e	34
Calculation History and Replay	34
Calculation History	34
Replay	35
Using Memory Functions	35
Answer Memory (Ans)	35
Variables (A, B, C, D, E, F, x, y, z)	36
Clearing the Contents of All Memories	38
Changing Calculation Result Format	39
Using the FORMAT Menu	39
FORMAT Menu List	39
Conversion Sample Operation	40
Standard and Decimal Conversion	40
Prime Factorization	41
Rectangular and Polar Coordinate Conversion	42
Improper Fraction and Mixed Fraction Conversion	43
Engineering Notation	43
Sexagesimal Conversion (Degree, Minute, Second Calculations)	44
Converting a Decimal Value Calculation Result to a Sexagesimal Value	44
Inputting and Calculating with a Sexagesimal Value	45
Advanced Calculations	46
Function Analysis	46
Derivative(d/dx)	46
Integration(\int)	47
Summation(Σ)	49
Logarithm(\log_{ab}), Logarithm(\log)	50
Natural Logarithm	50
Probability	50
%	51
Factorial(!)	51
Permutation(P), Combination(C)	51
Random Number	52
Random Integer	52
Numeric Calculations	53
Absolute Value	53
Round Off	53
Angle Unit, Polar/Rectangular Coordinate, Sexagesimal	54
Degrees, Radians, Gradians	54
Rect to Polar, Polar to Rect	54
Degrees, Minutes, Seconds	55
Hyperbolic, Trigonometric	55
Hyperbolic Functions	55
Trigonometric Functions	55

Engineering Symbols	56
Scientific Constants	57
Unit Conversions	58
Others	60
Registering and Using Defining Equations for $f(x)$ and $g(x)$	61
Registering and Using Defining Equations for $f(x)$ and $g(x)$	61
Registering a Defining Equation	61
Performing a Calculation by Assigning a Value to the Registered Defining Equation	62
Registering a Composite Function	62
Data Retention	63
Using QR Code Functions	64
Using QR Code Functions	64
Displaying a QR Code	64
If You Experience Difficulty Scanning a QR Code	65
Using Calculator Apps	66
Statistical Calculations	66
General Procedure for Performing a Statistical Calculation	66
Inputting Data with Statistics Editor	67
Displaying Statistical Calculation Results	70
Using Statistical Calculation Screen	74
Statistical Calculation Formula	80
Distribution Calculations	83
General Procedure for Performing a Distribution Calculation	84
Parameter List	85
List Screen	86
Editing the List Screen Contents	87
Calculation Example	87
Using Spreadsheet	88
Inputting and Editing Cell Contents	88
Inputting a Constant and Formula into a Cell	89
Cell Relative and Absolute References	90
Using Spreadsheet App Special Commands	92
Batch Inputting the Same Formula or Constant into Multiple Cells	93
Spreadsheet App Setting Items	94
Auto Calc and Recalculate	95
Creating a Number Table	95
General Procedure for Creating a Number Table	95
Maximum Number of Rows in a Number Table According to Table Type	96
Defining Equation Registration	97
Editing Number Table Screen Data	97
$f(x)$ and $g(x)$ Update Timing	98
Data Retention	99

Equation Calculations	99
Simultaneous Linear Equations	100
High-order Equations from 2nd to 4th Degree	101
Using Solver	105
Inequality Calculations	107
General Procedure for Performing an Inequality Calculation	107
Complex Number Calculations	109
Inputting Complex Numbers	109
Complex App Calculation Examples	109
Base- <i>n</i> Calculations	111
Specifying the Number Mode of a Particular Input Value	113
Converting a Calculation Result to Another Type of Value	113
Logical and Negation Operations	114
Matrix Calculations	114
General Procedure for Performing a Matrix Calculation	114
Matrix Variable List Screen	116
Matrix Answer Memory (MatAns)	119
Matrix Calculation Examples	119
Vector Calculations	122
General Procedure for Performing a Vector Calculation	122
Vector Variable List Screen	124
Vector Answer Memory (VctAns)	126
Vector Calculation Examples	126
Ratio Calculations	128
General Procedure for Performing a Ratio Calculation	128
Calculation Example	129
Using Math Box	129
Dice Roll	129
Coin Toss	133
Technical Information	137
Errors	137
Displaying the Location of an Error	137
Error Messages	137
Before Assuming Malfunction of the Calculator... ..	141
Replacing the Battery	141
Calculation Priority Sequence	143
Calculation Ranges, Number of Digits, and Precision	144
Calculation Range and Precision	144
Function Calculation Input Ranges and Precision	144
Specifications	147
Frequently Asked Questions	148
Frequently Asked Questions	148

Before Using the Calculator

Read This First

About This Manual

- In no event shall CASIO Computer Co., Ltd. be liable to anyone for special, collateral, incidental, or consequential damages in connection with or arising out of the purchase or use of this product and items that come with it. Moreover, CASIO Computer Co., Ltd. shall not be liable for any claim of any kind whatsoever by any other party arising out of the use of this product and the items that come with it.
- The contents of this manual are subject to change without notice.
- The displays and illustrations (such as key markings) shown in this manual are for illustrative purposes only, and may differ somewhat from the actual items they represent.
- QR Code is a registered trademark of DENSO WAVE INCORPORATED in Japan and in other countries.
- Company and product names used in this manual may be registered trademarks or trademarks of their respective owners.

Key Operations

The example below shows how key operations are represented in this manual.

Example 1: AC $\sqrt{\square}$ 9 EXE

Keys should be pressed in the sequence shown above (left to right).

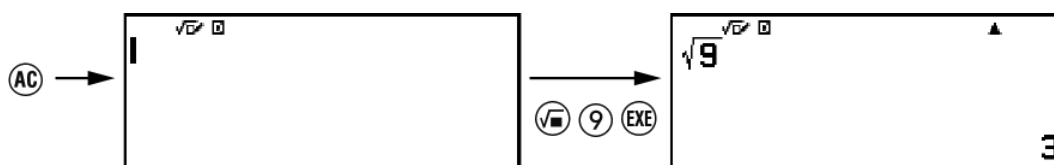

Example 2: \uparrow 7 $(\pi)^*$

The above indicates you should press \uparrow and then 7 , which will input a π symbol. All multiple-key input operations are indicated like this. Key cap markings are shown, followed by the input character or command in parentheses.

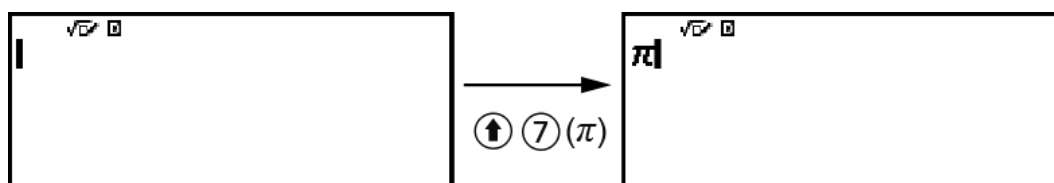

* Refer to **"Key Markings" (page 13)** for more information about the key symbols used in this example.

Example 3: ⤴, ⤵, ⤶, ⤷, ⤴⤵, ⤶⤷

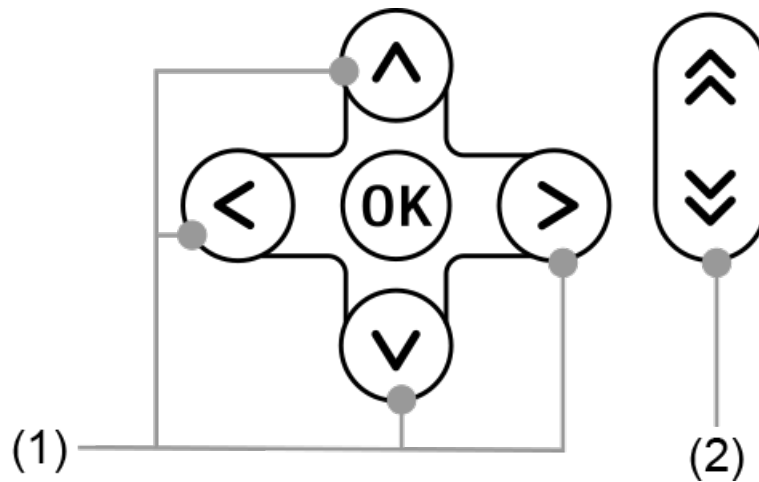

- Individual cursor keys indicated by (1) are represented as ⤴, ⤵, ⤶, ⤷.
- Individual page scroll keys indicated by (2) are represented as ⤴⤵, ⤶⤷.

Menu Operations

Some operations in this manual use a simplified form of menu operations, as shown in the examples below.

Example 1

⊞ – [Other] > [π]

or

Press ⊞, and then select [Other] > [π].



Actual Operation 1

1. Press ⊞.
2. Use ⤴ and ⤵ to select [Other], and then press OK.
3. Use ⤴ and ⤵ to select [π], and then press OK.







Example 2

⊞ - Calculate









or

Press , select the Calculate app icon, and then press .

Actual Operation 2

1. Press .
2. Use the cursor keys (, , , ) to select the Calculate app icon, and then press .

Key and Key

The  key and  key perform the same operation. In this manual,  is used for selecting or applying a setting, while  is used for executing a calculation. Note, however, that it makes no difference whether you press  or  for operations where either  or  is shown.

Examples

If you are not instructed to use a specific calculator app or to configure particular settings for an example operation, the app and settings below are assumed.

Calculator app: Calculate







Settings: Initial default calculator settings

For information about returning the calculator to its initial default settings, see ["Initializing the Calculator" \(page 7\)](#).

Initializing the Calculator

Important!

- The procedure below initializes all calculator settings, except for Contrast and Auto Power Off. Also clears all data stored in calculator memory.

1. Press  to display the HOME screen.
2. Use the cursor keys (, , , ) to select a calculator app icon, and then press .
3. Press , and then select [Reset] > [Initialize All] > [Yes].
 - This displays the HOME screen.

Calculator "Get Started" Screen

While the HOME screen is displayed, pressing the  key will display the "Get Started" screen, which includes the information below.

- QR Code for accessing the "Get Started" webpage of the Worldwide Education Service (<https://wes.casio.com/calc/cw/>)
The Get Started webpage gives you access to the User's Guide and other related information to help you get started with your calculator.
- Calculator ID number (24-character string)

Press  to return to the HOME screen.

Note

- You can also display the Get Started screen, by selecting it from the SETTINGS menu. See "[Using the SETTINGS Menu](#)" (page 19).

Precautions

Safety Precautions

Thank you for purchasing this CASIO product.

Be sure to read the "Safety Precautions" before using this product to ensure that you use it correctly. Be sure to keep all user documentation handy for future reference.



Danger

Indicates something that creates the major risk of death or serious personal injury.

■ Button Type and Coin Type Battery Precautions (fx-991CW only)



Take care to ensure that a battery will not be swallowed accidentally.

Particular care is required to keep batteries away from children.

Should a battery be swallowed accidentally or if there is a possibility that a battery has been swallowed, immediately contact a physician. Swallowing a battery can result in chemical burns, mucosal tissue penetration, and other serious problems that create the risk of death.



Warning

Indicates something that creates the risk of death or serious personal injury.

■ Display Screen

 **Do not press the LCD or subject it to strong impact.**

Doing so can cause the LCD glass to crack, creating the risk of personal injury.

 **Should the LCD become cracked, never touch any of the liquid inside.**

LCD liquid getting on the skin creates the risk of skin irritation.

Should LCD liquid get into your mouth, immediately rinse your mouth out and contact your physician.

Should LCD liquid get in your eyes or on your skin, rinse with clean water and then contact your physician.

■ Battery Precautions

 **Should fluid leaking from a battery get on your skin or clothing, immediately rinse it off with clean water.**

Battery fluid getting into the eyes creates the risk of eyesight loss, etc.

Rinse the eyes and then immediately contact a physician.



Caution

Indicates something that creates the risk of minor personal injury or physical damage.

Observe the precautions below. Failure to do so can cause a battery to rupture, creating the risk of fire, personal injury, and soiling of nearby objects by leaking fluid.



- Do not try to take a battery apart and never allow a battery to become shorted.
- Do not charge a non-rechargeable battery.
- Do not expose a battery to heat or throw it into fire.

• Use only the specified type of battery.



- Load a battery with its poles (plus (+) and minus (-)) facing correctly.
- Replace the battery as soon as possible after it goes dead.



Battery Precautions



Observe the precautions below. Failure to do so can cause the battery to explode or leak flammable liquid or gas.

- Use only the type of battery that is specified for this product.
- Do not burn a battery or dispose of it in an incinerator, or by mechanical crushing or cutting.
- Do not subject a battery to excessively high or low temperatures during use, storage, or transport.
- Do not subject a battery to excessively low barometric pressure during use, storage, or transport.

Handling Precautions

- fx-570CW: Even if the calculator is operating normally, replace the battery at least once every two years (R03).
fx-991CW: Even if the calculator is operating normally, replace the battery at least once every two years (LR44).
A dead battery can leak, causing damage to and malfunction of the calculator. Never leave a dead battery in the calculator. Do not try using the calculator while the battery is completely dead (fx-991CW).
- You will be charged for malfunction or damage due to battery leakage, which is not covered by the warranty.
- The battery that comes with the calculator discharges slightly during shipment and storage. Because of this, it may require replacement sooner than the normal expected battery life.
- Avoid use and storage of the calculator in areas subjected to temperature extremes, and large amounts of humidity and dust.
- Do not subject the calculator to excessive impact, pressure, or bending.
- Never try to take the calculator apart.
- Use a soft, dry cloth to clean the exterior of the calculator.
- Whenever discarding the calculator or batteries, be sure to do so in accordance with the laws and regulations in your particular area.

Getting Started

Attaching and Removing the Front Cover

To remove the front cover

Before using the calculator, remove the front cover (①) and attach it to the back (②).

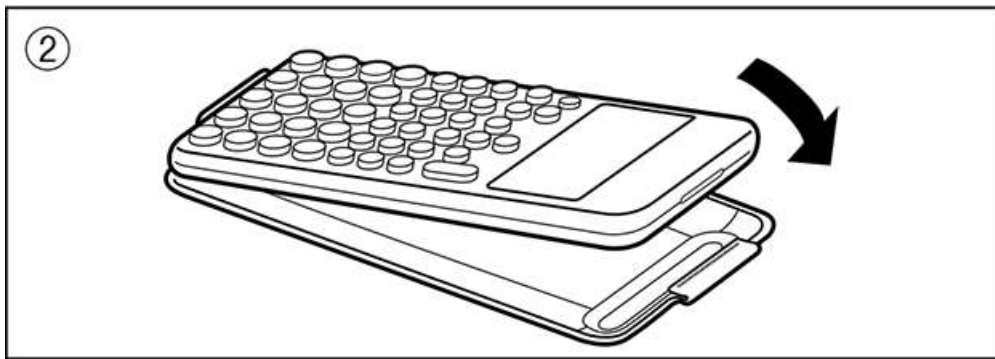
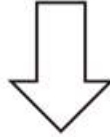
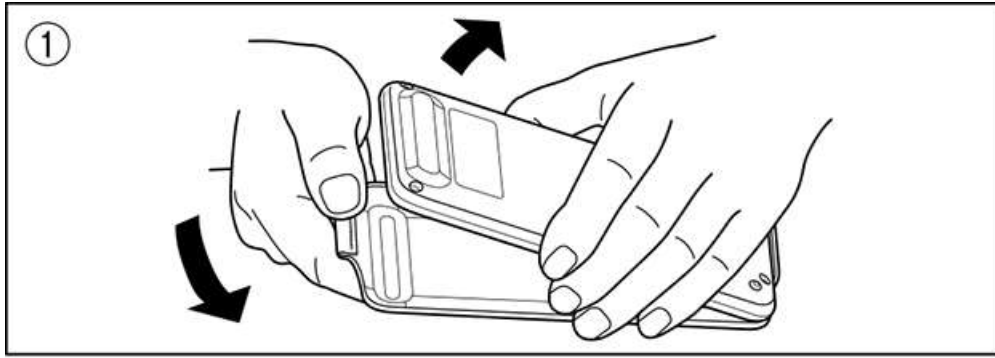

To attach the front cover

When you are not using the calculator, remove the front cover (①) and attach it to the front (②).

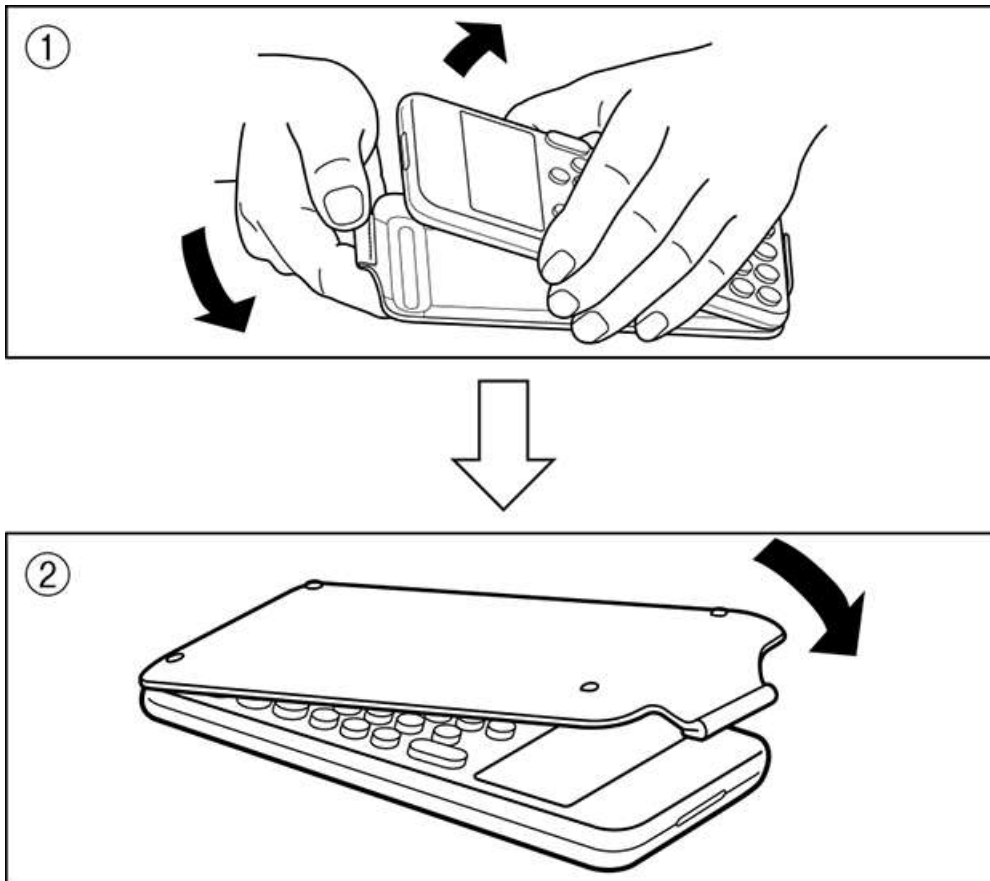

Important!



- Always attach the front cover to the calculator whenever you are not using it. Otherwise, accidental operation of the  key can cause the power to turn on and run down the battery.

Turning Power On and Off

Press  to turn on the calculator.

Press  (AC) (OFF) to turn off the calculator.

Note

- To turn on power, long-press . To avoid turning on power accidentally, the top of  key is slightly lower than the other keys.
- If the screen shown below appears right after you turn on power, it means that remaining battery power is low.



If this screen appears, replace the battery as soon as possible. For details about battery replacement, see ["Replacing the Battery" \(page 141\)](#).

- The calculator also will turn off automatically after approximately 10 minutes or 60 minutes of non-use. Press the  key to turn the calculator back on.

HOME Screen

Pressing \odot displays the HOME screen. The HOME screen shows a list of installed calculator apps.

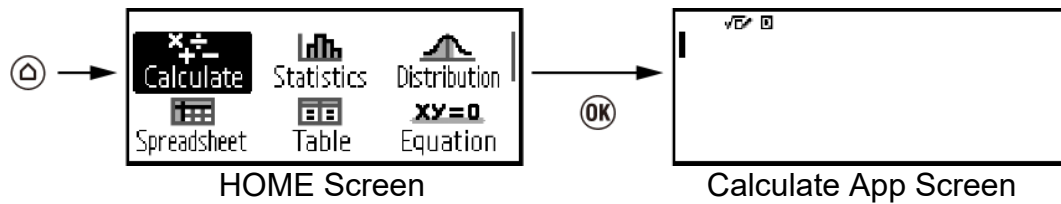

For information about installed calculator apps, see ["Installed Calculator App List" \(page 17\)](#).

Adjusting Display Contrast

1. Press \odot , select a calculator app icon, and then press OK .
2. Press Menu , and then select [System Settings] > [Contrast].

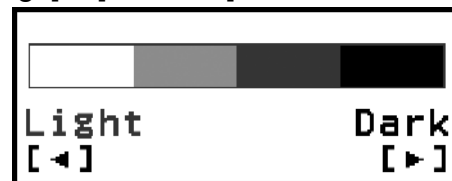

3. Use \leftarrow and \rightarrow to adjust display contrast.
4. After the setting is the way you want, press AC .

Important!

- If adjusting display contrast does not improve display readability, it probably means that battery power is low. Replace the battery.

Key Markings

Pressing the \uparrow key followed by a second key performs the alternate function of the second key. The alternate function is indicated by the text printed above the key, on the left.

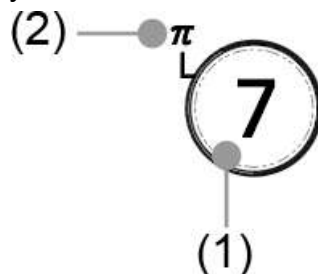





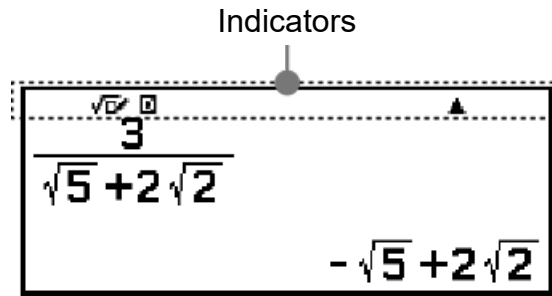

- (1) Keycap function: 7
- (2) Alternate function: $\uparrow \text{7} (\pi)$

Indicators



The table below describes indicators that appear at the top of the screen.

This indicator:	Means this:
S	The keypad has been shifted by pressing the  key. The keypad will unshift and this indicator will disappear when you press a key.
	MathI/MathO or MathI/DecimalO is selected for Input/Output on the SETTINGS menu.
D / R / G	Current setting of Angle Unit (D : Degree, R : Radian, or G : Gradian) on the SETTINGS menu.
FIX	A fixed number of decimal places is in effect.
SCI	A fixed number of significant digits is in effect.
E	On is selected for Engineer Symbol on the SETTINGS menu.
i/\angle	Current setting of Complex Result (i : $a+bi$ or \angle : $r\angle\theta$) on the SETTINGS menu.
 / 	There is previous () or following () calculation history for the currently displayed calculation result. With some calculator apps, these indicators indicate there are other calculation results available.
	Calculator is being powered directly by its solar cells, either entirely or in some combination with the battery. (fx-991CW only)

Using Menus

Many of the operations of your calculator are performed using menu screens. The example below shows operations starting from the menu screen that appears when you press ☰ .

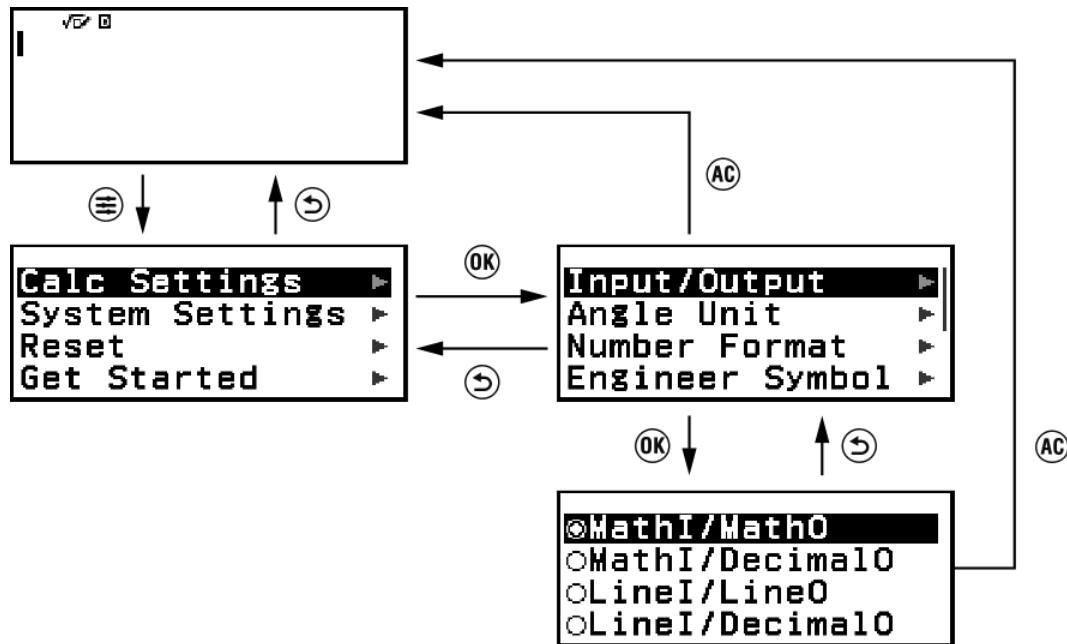

Selecting a Menu Item

To select a menu item, use the cursor keys (⬆ , ⬇ , ⬅ , ➡) to highlight it and then press **OK**. Note that ⬅ and ➡ are used only when there are multiple menu item columns.

Navigating Between Menu Hierarchies

The "▶" indicator to the right of a menu item means that there are lower hierarchy levels under that item. Selecting the menu item and pressing **OK** or ➡ navigates the next lower level of the hierarchy. To return to the next upper level of the hierarchy, press ⬅ .



Note

- If you are in a lower level of the hierarchy of a one-column menu, you can press ⬅ in addition to ⬅ to return to the next higher level.

Selecting a Menu Item with a Radio Button (/)





When the display shows a list of multiple options, each option will have a radio button (or) to its left. indicates the currently selected option.

To configure the setting of a radio button menu item

1. Highlight the applicable menu item and then press **OK**.
 - What happens next depends on the type of menu item you selected.
 - If there are no more settings to configure for the menu item you selected, the radio button next to it will change to .
 - The menu item you selected has more settings to configure, a screen for selecting the menu item setting will appear. In this case, proceed to step 2.
2. On the setting screen, highlight the setting you want and then press **OK**.
 - This returns to the menu item screen in step 1, with the radio button next to the menu item you previously selected changed to .

Scrolling Between Screens







A scroll bar will appear along the right side of the display when there are so many menu items that they do not fit on one screen.

- Use  and  to scroll between screens.
- Use  and  to scroll line-by-line.

To close the menu and return to the screen displayed before the menu

Press **AC**.

Note

- You can close a menu displayed by pressing , , , , , or  by pressing **AC**. If the displayed menu is one that appears immediately after launching a particular calculator app or if it is an app-specific menu, you cannot close it by pressing **AC**. In that case, you must press  to close the menu.

Calculator Apps and Menus

Calculator Apps

Selecting a Calculator App



Select a calculator app that is suitable for the type of calculation you want to perform.

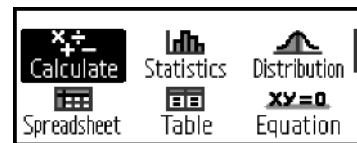





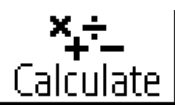

1. Press \odot to display the HOME screen.
 - For information about each calculator app, see the ["Installed Calculator App List" \(page 17\)](#).





2. Use the cursor keys (\wedge , \vee , \leftarrow , \rightarrow) to select the calculator app icon you want.
3. Press \textcircled{OK} to display the initial screen of the calculator app whose icon you selected.

Installed Calculator App List

Icon	Description
 Calculate (Calculate)	General calculations
 Statistics (Statistics)	Statistical and regression calculations
 Distribution (Distribution)	Distribution calculations

 <u>Spreadsheet</u> (Spreadsheet)	Spreadsheet calculations
 <u>Table</u> (Table)	Generates a number table based on one or two functions
 <u>Equation</u> (Equation)	Simultaneous equations, higher-order equations, and Solver (function to find the value of any variable contained in an input equation)
 <u>Inequality</u> (Inequality)	Inequality calculations
 <u>Complex</u> (Complex)	Complex number calculations
 <u>Base-N</u> (Base-N)	Calculations involving specific number systems (binary, octal, decimal, hexadecimal)
 <u>Matrix</u> (Matrix)	Matrix calculations
 <u>Vector</u> (Vector)	Vector calculations

 Ratio (Ratio)	Ratio calculations
 Math Box (Math Box)	The following functions to support math learning. Dice Roll, Coin Toss: Probability simulation



Using the SETTINGS Menu

To display the SETTINGS menu, press  while using a calculator app. The SETTINGS menu includes the menu items below.



Calc Settings	Includes menu items for configuring calculation settings, such as the display format for calculation results.
System Settings	Includes menu items for configuring calculator operation settings, such as contrast adjustment.
Reset	Includes menu items for performing various types of reset operations.
Get Started	Displays the Get Started screen. For more information, see "Calculator "Get Started" Screen" (page 7) .

Note

- Pressing  while the HOME screen is displayed will display the Get Started screen instead of the SETTINGS menu.
- Depending on the screen displayed by the calculator app, pressing  may not display the SETTINGS menu.

Changing Calculator Settings

1. Press , select a calculator app icon, and then press .

2. Press ☰ to display the SETTINGS menu.

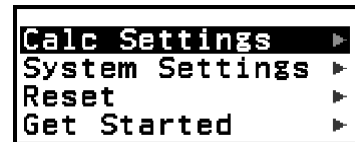

3. Use ▲ and ▼ to select Calc Settings or System Settings, and then press OK .

- This displays a list of setting items included on the selected menu. The screen here shows an example of what appears when [Calc Settings] is selected.

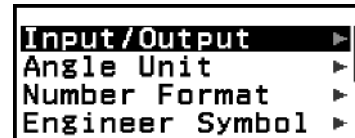

• See "[Items and Available Setting Options](#)" (page 20) for the setting items included for [Calc Settings] and [System Settings].

4. Use ▲ and ▼ to highlight the item whose setting you want to change, and then press OK .

- This displays a list of setting options for the item you selected. The screen here shows an example of what appears when [Input/Output] is selected.

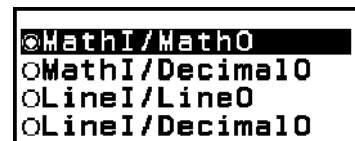

5. Use ▲ and ▼ to highlight the option you want, and then press OK .

6. After the setting is the way you want, press AC .

Items and Available Setting Options

"◆" indicates the initial default setting.

Calc Settings > Input/Output

Specifies the format to be used by the calculator for expression input and calculation result output.

MathI/MathO◆	Input: Natural Textbook; Output: Format that includes a fraction, $\sqrt{\quad}$, and/or π^{*1}
MathI/DecimalO	Input: Natural Textbook; Output: Converted to decimal value

LineI/LineO	Input: Linear ^{*2} ; Output: Decimal or fraction
LineI/DecimalO	Input: Linear ^{*2} ; Output: Converted to decimal value

*1 Decimal output is applied when these formats cannot be output for some reason.

*2 All calculations, including fractions and functions are input in a single line. Same output format as that for models without Natural Textbook Display (S-V.P.A.M. models, etc.)

Input/output format display examples:

MathI/MathO
(initial default setting)

$\frac{1}{200}$	$\frac{1}{200}$
-----------------	-----------------

MathI/DecimalO
(Number Format: Norm 1)

$\frac{1}{200}$	5×10^{-3}
-----------------	--------------------

(Number Format: Norm 2)

$\frac{1}{200}$	0.005
-----------------	-------

LineI/LineO

1J200	1J200
-------	-------

LineI/DecimalO
(Number Format: Norm 1)

1J200	5×10^{-3}
-------	--------------------

Calc Settings > Angle Unit

Degree[◆]; Radian; Gradian

Specifies degree, radian or gradian as the angle unit for value input and calculation result display.

Calc Settings > Number Format

Specifies the number of digits for display of a calculation result.

Fix: The value you specify (from 0 to 9) controls the number of decimal places for displayed calculation results. Calculation results are rounded off to the specified digit before being displayed.

Example: $1 \div 6$

(Fix 3)

$1 \div 6 \uparrow \text{EXE} (\approx)^*$

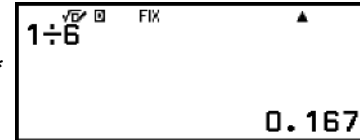

Sci: The value you specify (from 1 to 10) controls the number of significant digits for displayed calculation results. Calculation results are rounded off to the specified digit before being displayed.

Example: $1 \div 6$

(Sci 3)

$1 \div 6 \uparrow \text{EXE} (\approx)^*$

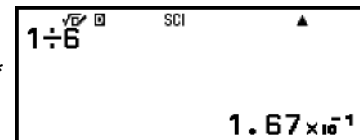

Norm: Displays calculation results in exponential format when they fall within the ranges below.

Norm 1♦: $10^{-2} > |x|$, $|x| \geq 10^{10}$, Norm 2: $10^{-9} > |x|$, $|x| \geq 10^{10}$

Example: $1 \div 200$

(Norm 1)

$1 \div 200 \uparrow \text{EXE} (\approx)^*$

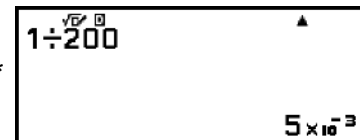

(Norm 2)

$1 \div 200 \uparrow \text{EXE} (\approx)^*$

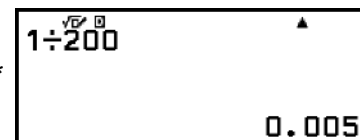

* Pressing $\uparrow \text{EXE} (\approx)$ instead of EXE after inputting a calculation will display the calculation result in decimal form.

Calc Settings > Engineer Symbol

On; Off♦

Specifies whether or not to display calculation results using engineering symbols.

Note

- An indicator (E) is displayed at the top of the screen while On is selected for this setting.

Calc Settings > Fraction Result

Mixed Fraction; Improper Fraction♦

Specifies either mixed fraction or improper fraction for display of fractions in calculation results.

Calc Settings > Complex Result

$a+bi$ ♦; $r\angle\theta$

Specifies either rectangular coordinates or polar coordinates for Complex app calculation results and Equation app polynomial solutions.

Note

- An i indicator is displayed at the top of the screen while $a+bi$ is selected for the Complex Result setting. \angle is displayed while $r\angle\theta$ is selected.

Calc Settings > Decimal Mark

Dot♦; Comma

Specifies whether to display a dot or a comma for the calculation result decimal mark. A dot is always displayed during input. When dot is selected as the decimal mark, the separator for multiple results is a comma (,). When comma is selected, the separator is a semicolon (;).

Calc Settings > Digit Separator

On; Off♦

Specifies whether or not a separator character should be used in calculation results.

System Settings > Contrast

See ["Adjusting Display Contrast" \(page 13\)](#).

System Settings > Auto Power Off

10 Min. \blacklozenge ; 60 Min.

Specify the amount of time until Auto Power Off is triggered.

System Settings > MultiLine Font

Normal Font \blacklozenge ; Small Font

Specifies the display font size when LineI/LineO or LineI/DecimalO is selected for Input/Output. Up to four lines can be displayed while Normal Font is selected, and up to six lines can be displayed with Small Font.

System Settings > QR Code

Specifies the version of the QR Code displayed when \uparrow \otimes (QR) is pressed.

Version 3: Indicates QR Code Version 3.

Version 11 \blacklozenge : Indicates QR Code Version 11.

Reset > Settings & Data

See ["To initialize calculator settings" \(page 24\)](#).

Reset > Variable Memory

See ["Clearing the Contents of All Memories" \(page 38\)](#).

Reset > Initialize All

See ["Initializing the Calculator" \(page 7\)](#).

Get Started

See ["Calculator "Get Started" Screen" \(page 7\)](#).

To initialize calculator settings

Important!

- The procedure below initializes all calculator settings, except for Contrast and Auto Power Off. Also clears all data except for variable memory and Ans data.

1. Press \odot , select a calculator app icon, and then press OK .
2. Press \equiv , and then select [Reset] > [Settings & Data] > [Yes].
 - This displays the HOME screen.

Using the CATALOG Menu

Press \odot to display the CATALOG menu. This menu shows categories of the commands, functions, and symbols in accordance with the calculator app you are currently using and the current status (displayed screen or current settings) of the app.

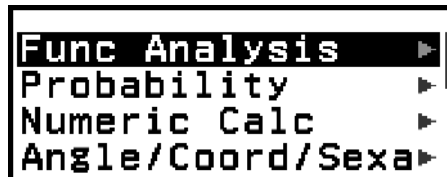

Example: CATALOG menu of the Calculate app

Note

- For information about how to input commands, functions, and symbols from the CATALOG menu, see ["Advanced Calculations" \(page 46\)](#).
- For information about the commands, functions, and symbols specific to each calculator app, refer to the calculator app descriptions in ["Using Calculator Apps" \(page 66\)](#).

Using the TOOLS Menu

The TOOLS menu that appears when you press \odot includes menu items for performing functions specific to each calculator app and for configuring settings.



Example: TOOLS menu for the Calculate app

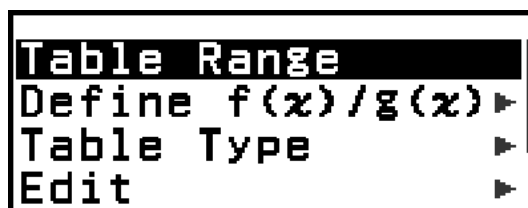

Examples: TOOLS menu for the Table app

Note

- The menu items below are common to multiple calculator apps.
 - Undo (See "[Undo Operations](#)" (page 29).)

Inputting Expressions and Values

Basic Input Rules

When you press EXE the priority sequence of the input calculation will be evaluated automatically and the result will appear on the display.

$$4 \times \sin 30 \times (30 + 10 \times 3) = 120$$

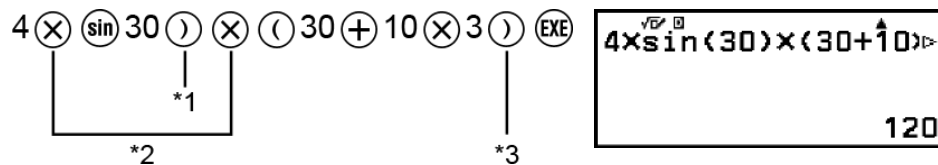

- *1 Input of the closing parenthesis is required for sin and other functions that include parentheses.
- *2 These multiplication symbols (x) can be omitted.
- *3 The closing parenthesis immediately before the EXE operation can be omitted.

Moving the Cursor to the Beginning or End of an Input Expression

While inputting an expression, you can press HOME to make the cursor jump to the beginning of the expression or END to jump to the end of the expression.

Input Expression and Calculation Result "More" Indicator (▶ , ▶)

If you see a pointer (▶ or ▶) symbol on the right side of either an input expression line or calculation result line, it means the displayed line continues to the right. Use LEFT and RIGHT to scroll the line left and right.

- When you see ▶ at the right end of a calculation result line, you can jump to the end of the result by pressing END . To jump to the beginning of a calculation result line, press HOME .
- Note that if you want to scroll the input expression while both the ▶ and ▶ indicators are displayed, you will need to press ON or AC first and then use LEFT and RIGHT to scroll.

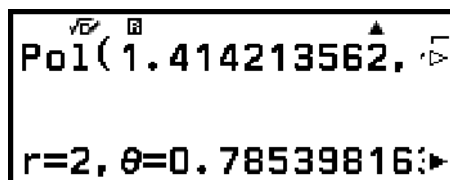

Parentheses Auto Complete

If you execute a calculation that includes both division and multiplication operations in which a multiplication sign has been omitted, parentheses will be inserted automatically as shown in the examples below.

- When a multiplication sign is omitted immediately before an open parenthesis or after a closing parenthesis.

Example: $6 \div 2(1 + 2) \rightarrow 6 \div (2(1 + 2))$

- When a multiplication sign is omitted immediately before a variable, a constant, etc.

Example: $6 \div 2\pi \rightarrow 6 \div (2\pi)$

Input Limit Indication

The cursor will change shape to ■ when there are 10 bytes or less of allowed input remaining. If this happens, end calculation input and then press EXE .

Inputting an Expression Using Natural Textbook Format (MathI/MathO or MathI/DecimalO Only)

Expressions that include fractions and/or special functions such as $\sqrt{\quad}$ can be input in natural textbook format by using templates that appear when certain keys are pressed, or when you input certain functions from the CATALOG menu.

Example: $3\frac{1}{2} + 5\frac{3}{2}$

1. Press \uparrow $\frac{\square}{\square}$ ($\frac{\square}{\square}$).

- This inputs a mixed fraction template.

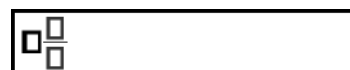

2. Input values into the integer, numerator, and denominator areas of the template.



3. Do the same to input the remainder of the expression.

$$\left[\left(\left(3 \frac{1}{2} + 5 \frac{3}{2} \right) \right) \right] \left[\left(- \frac{5}{2} \right) \right] 5 \left[\left(\left(3 \right) \right) \right] \left[\left(\left(2 \right) \right) \right] \left[\left(\left(\text{EXE} \right) \right) \right]$$

$3 \frac{1}{2} + 5 \frac{3}{2}$
10

Note

- While the input cursor is located within the input area of a template (mixed fractions, integration (∫) and summation (Σ)), pressing $\left[\left(\left(\uparrow \right) \right) \right] \left[\left(\left(\right) \right) \right]$ jumps to the position immediately following (to the right of) the template, while pressing $\left[\left(\left(\uparrow \right) \right) \right] \left[\left(\left(\leftarrow \right) \right) \right]$ jumps to the position immediately before (to the left of) it.
- You can always tell the current location of the cursor within a template because the blank framed area or the characters where it is located will be dark black. Everything else in the calculation expression will be dark gray.



Undo Operations

To undo the last key operation, press $\left[\left(\left(\circ \circ \circ \right) \right) \right]$, select [Undo], and then press $\left[\left(\left(\text{OK} \right) \right) \right]$.

To redo a key operation you have just undone, press $\left[\left(\left(\circ \circ \circ \right) \right) \right]$, select [Undo], and then press $\left[\left(\left(\text{OK} \right) \right) \right]$ again.

Using Values and Expressions as Arguments

Example: To input $1 + \frac{7}{6}$ and then change it to $1 + \sqrt{\frac{7}{6}}$

$$1 \left[\left(\left(+ \right) \right) \right] 7 \left[\left(\left(\frac{\square}{\square} \right) \right) \right] 6 \left[\left(\left(\leftarrow \right) \right) \right] \left[\left(\left(\leftarrow \right) \right) \right] \left[\left(\left(\uparrow \right) \right) \right] \left[\left(\left(\text{INS} \right) \right) \right]$$

$1 + \frac{7}{6}$

$$\left[\left(\left(\sqrt{\square} \right) \right) \right]$$

$1 + \sqrt{\frac{7}{6}}$

Pressing $\left[\left(\left(\uparrow \right) \right) \right] \left[\left(\left(\text{INS} \right) \right) \right]$ in the above example causes $\frac{7}{6}$ to be the argument of the function input by the next key operation ($\sqrt{\square}$).

Overwrite Input Mode (LineI/LineO or LineI/DecimalO Only)

In the overwrite mode, text you input replaces the text at the current cursor location. You can toggle between the insert and overwrite modes by performing the operation: $\left[\left(\left(\uparrow \right) \right) \right] \left[\left(\left(\text{INS} \right) \right) \right]$. The cursor appears as "I" in the insert mode and as "—" in the overwrite mode.

Basic Calculations

Arithmetic Calculations

Use the \oplus , \ominus , \otimes , and \odiv keys to perform arithmetic calculations.

Example: $7 \times 8 - 4 \times 5 = 36$

$7 \otimes 8 \ominus 4 \otimes 5 \text{EXE}$

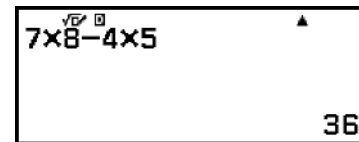

Fraction Calculations

Note that the input method for fractions depends on the current Input/Output setting on the SETTINGS menu.

To input $\frac{7}{3}$ (improper fraction)

(Input/Output: MathI/MathO or MathI/DecimalO)

$\text{7} \text{ } \text{3} \text{ or } \text{7} \text{ } \text{3}$	$\frac{7}{3}$
---	---------------

(Input/Output: LineI/LineO or LineI/DecimalO)

$7 \text{ } \text{3}$	$\begin{array}{ccc} & 7 & \text{ } 3 \\ & \swarrow & \searrow \\ \text{(a)} & & \text{(b)} \end{array}$
-----------------------	---

(a) Numerator, (b) Denominator

To input $2 \frac{1}{3}$ (mixed fraction)

(Input/Output: MathI/MathO or MathI/DecimalO)

$\text{2} \text{ } \text{1} \text{ } \text{3}$	$2 \frac{1}{3}$
--	-----------------

(Input/Output: LineI/LineO or LineI/DecimalO)

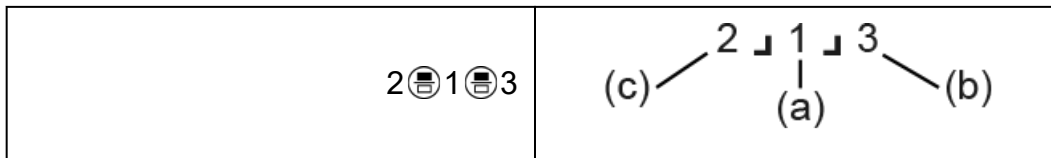

(a) Numerator, (b) Denominator, (c) Integer Part

Example: $\frac{2}{3} + 1\frac{1}{2} = \frac{13}{6}$

(Input/Output: MathI/MathO)

$2 \frac{1}{3} + 1 \frac{1}{2}$ (using fraction format keys)

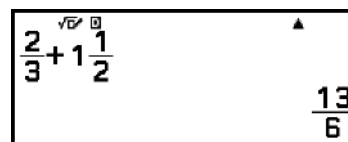

(Input/Output: LineI/LineO)

$2 \frac{1}{3} + 1 \frac{1}{2}$ (using line input keys)

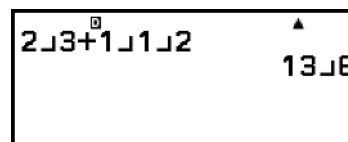

Note

- Fractions in calculation results are displayed after being reduced to their lowest terms.

To convert a calculation result format to improper fraction or mixed fraction, press $\frac{\square}{\square}$. For more information, see ["Improper Fraction and Mixed Fraction Conversion" \(page 43\)](#).

Fraction Format Calculation Results

A calculation result whose total number of mixed fraction number of digits (including integer, numerator, denominator, and separator symbol $\frac{\square}{\square}$) is greater than 10 cannot be displayed using fraction format. In this case, the calculation result is displayed as a decimal value.

Example 1: $1 \frac{1}{1} \frac{123456}{123456} = 123457 \frac{123456}{123456}$

(Input/Output: LineI/LineO)

$1 \frac{1}{1} \frac{123456}{123456}$ (using line input keys)

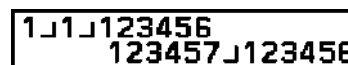

Since the total number of digits of the value $1 \frac{1}{1} \frac{123456}{123456}$ is 10, the result is displayed as a fraction value.

Example 2: $1 \frac{1}{1} \frac{1234567}{1234567} (= 1234568 \frac{1234567}{1234567}) = 1.00000081$

(Input/Output: LineI/LineO)

1 $\frac{\square}{\square}$ 1 $\frac{\square}{\square}$ 1234567 $\frac{\square}{\square}$ EXE

1 $\frac{\square}{\square}$ 1 $\frac{\square}{\square}$ 1234567
1.00000081

Since the total number of digits of the value 1 $\frac{\square}{\square}$ 1 $\frac{\square}{\square}$ 1234567 is 11, the result is displayed as a decimal value.

Note

- Mixing fractions and decimal values in a calculation while something other than MathI/MathO is selected will cause the result to be displayed as a decimal value.

Powers, Power Roots, and Reciprocals

Use the keys below to input power functions, power root functions, and reciprocal function.

Power functions: $\frac{\square}{\square}$ (square), $\frac{\square}{\square}$ (n^{th} power)

Power root functions: $\sqrt{\square}$ (square root), $\sqrt[n]{\square}$ (n^{th} root)

Reciprocal function: $\frac{\square}{\square}$ (\square^{-1})

Example 1: $(5^2)^3 = 15625$

(5 $\frac{\square}{\square}$) $\frac{\square}{\square}$ 3 EXE

$\sqrt{\square} \frac{\square}{\square}$
 $(5^2)^3$
15625

Example 2: $(1 + 1)^{2+2} = 16$

(1 + 1) $\frac{\square}{\square}$ 2 + 2 EXE

$\sqrt{\square} \frac{\square}{\square}$
 $(1+1)^{2+2}$
16

Example 3: $\sqrt{2} \times 3 = 3\sqrt{2} = 4.242640687\dots$

(Input/Output: MathI/MathO)

$\sqrt{\square}$ 2 > \times 3 EXE

$\sqrt{\square} \frac{\square}{\square}$
 $\sqrt{2} \times 3$
 $3\sqrt{2}$

(Input/Output: LineI/LineO)

$\sqrt{\square} 2 \text{) } \times 3 \text{ EXE}$

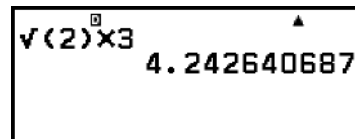

Example 4: ${}^5\sqrt{32} = 2$

(Input/Output: MathI/MathO)

$\uparrow \sqrt{\square} (\sqrt{\square}) 5 > 32 \text{ EXE}$



(Input/Output: LineI/LineO)

$5 \uparrow \sqrt{\square} (\sqrt{\square}) 32 \text{) EXE}$

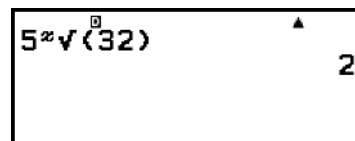

Example 5: $10^{-1} = \frac{1}{10}$

(Input/Output: MathI/MathO)

$10 \uparrow \square^{-1} \text{ EXE}$



$\times 10^{\square}$ Key (Power of 10)

Pressing the $\times 10^{\square}$ key is the same as pressing $\times 1 0 \square$. Both operations input " $\times 10^{\square}$ " (MathI/MathO or MathI/DecimalO) or " $\times 10^{(}$ " (LineI/LineO or LineI/DecimalO).

Example: $1.23 \times 10^3 = 1230$

$1 \text{ . } 23 \times 10^{\square} 3 \text{ EXE}$

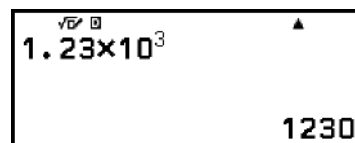

$\sqrt{\square}$ Form Calculation Range

The allowable display ranges of the $\sqrt{\square}$ form calculation result are shown below.

$$\pm a\sqrt{b}, \pm d \pm a\sqrt{b}, \pm \frac{a\sqrt{b}}{c} \pm \frac{d\sqrt{e}}{f}$$

$$1 \leq a < 100, 1 < b < 1000, 1 \leq c < 100$$

$$0 \leq d < 100, 0 \leq e < 1000, 1 \leq f < 100$$

Example:

- $10\sqrt{2} + 15 \times 3\sqrt{3} = 45\sqrt{3} + 10\sqrt{2} \dots$ Displayed in $\sqrt{\quad}$ form
- $99\sqrt{999} (= 297\sqrt{111}) = 3129.089165 \dots$ Displayed as a decimal value

Pi, Natural Logarithm Base e

Pi

Input π by pressing \uparrow $\textcircled{7}$ (π).

π is displayed as 3.141592654, but $\pi = 3.1415926535897932384626$ is used for internal calculations.

Natural Logarithm Base e

Input e by pressing \uparrow $\textcircled{8}$ (e).

Natural Logarithm Base e is displayed as 2.718281828, but $e = 2.7182818284590452353602$ is used for internal calculations.

Calculation History and Replay

Calculation History

An \blacktriangle and/or \blacktriangledown at the top of the screen indicates more calculation history content above and/or below. You can scroll through calculation history contents using $\textcircled{\wedge}$ and $\textcircled{\vee}$.

Apps that support calculation history:

Calculate, Complex, Base-N

Example

$2 + 2 = 4$

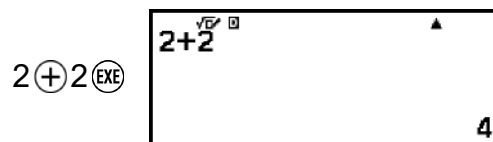

$3 + 3 = 6$

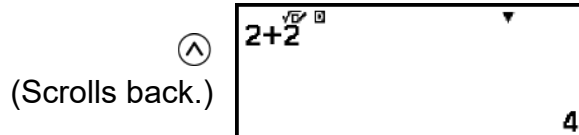
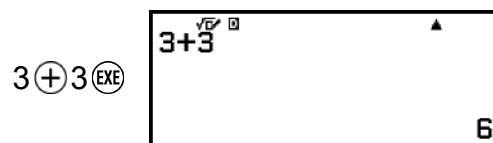

Note

- Calculation history data is all cleared whenever you press \uparrow or \downarrow , when you change the Input/Output setting, or whenever you perform a Reset operation ("Settings & Data" or "Initialize All").

Replay

While a calculation result is on the display, you can press \leftarrow , \rightarrow or \rightarrow to edit the expression you used for the previous calculation.

Example

$$4 \times 3 + 2 = 14$$

$$4 \times 3 + 2 \text{ EXE}$$

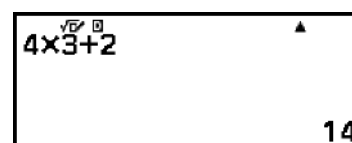

$$4 \times 3 - 7 = 5$$

$$\text{(Continuing)} \leftarrow \text{MC} \text{MC} - 7 \text{ EXE}$$

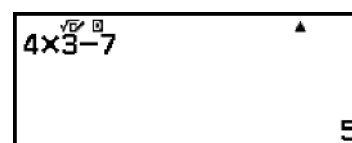

Note

- If \blacktriangleleft (left) or \blacktriangleright (right) is displayed on either end or both ends of a calculation result line, you can use \leftarrow and \rightarrow to scroll the line left and right. If this happens, press \rightarrow or AC first, and then use \leftarrow and \rightarrow to edit the expression.

Using Memory Functions

Answer Memory (Ans)

The last calculation result obtained is stored in Ans (answer) memory.

Using Ans Memory to Perform a Series of Calculations

Example: To divide the result of 3×4 by 30

$$3 \times 4 \text{ EXE}$$



$$\text{(Continuing)} \div 30 \text{ EXE}$$

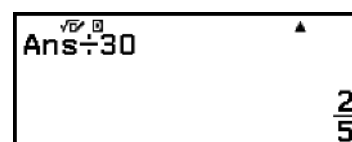

Inputting Ans Memory Contents into an Expression

Example: To perform the calculations shown below:

$$123 + 456 = 579 \qquad 789 - 579 = 210$$

$$123 \oplus 456 \text{ (EXE)} \quad \boxed{579}$$

(Continuing) $789 \ominus \text{ (Ans) (EXE)}$

Variables (A, B, C, D, E, F, x, y, z)

You can store values to variables and use the variables in calculations.

Variable List Screen

A=36	B=123456
C=1234567	D=12345678
E=123456789	F=1234567890
x=1.2345×10 ¹⁰	y=0
z=0	

Pressing $\text{2ND} \text{ (VARS)}$ displays a screen that shows the values currently stored to variables A, B, C, D, E, F, x, y, and z. On this screen, values are always displayed using the "Norm 1" Number Format. To close the screen, press $\text{2ND} \text{ (QUIT)}$ or AC .

Example 1: To store the result of $3 + 5$ to variable A

1. Execute the calculation.

$$3 \oplus 5 \text{ (EXE)} \quad \boxed{3+5 \text{ (EXE)} \quad 8}$$

2. Press $\text{2ND} \text{ (VARS)}$, and then select [A=] > [Store].

- This stores the result of $3 + 5$ (which is 8) to variable A.

3. Press $\text{2ND} \text{ (VARS)}$.

Example 2: To change the contents of variable A to 1

1. Press $\text{2ND} \text{ (VARS)}$, and then highlight [A=].

2. Press $\text{\textcircled{1}}$.

- This displays the editing screen with 1 entered.



A=1

3. Press $\text{\textcircled{EXE}}$.



A=1 B=0

Note

- In place of the operation in step 2 above, you can press $\text{\textcircled{OK}}$ and then select [Edit]. This displays the editing screen with nothing input. Input the value you want and then press $\text{\textcircled{EXE}}$.
- If a lock ($\text{\textcircled{L}}$) icon appears when you highlight a variable on the variable list screen, it means the highlighted variable cannot be edited.

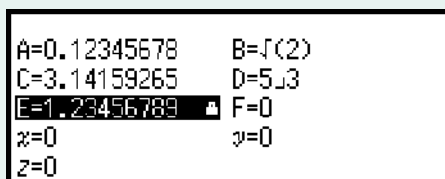

A=0.12345678 B=J(2)
C=3.14159265 D=5.3
E=1.23456789 $\text{\textcircled{L}}$ F=0
x=0 y=0
z=0

Example 3: To recall the contents of variable A
(Continuing from step 2 of Example 1)

1. Press $\text{\textcircled{2.3}}$, and then select [A=] > [Recall].

- This inputs "A".

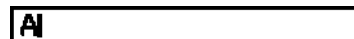

A

2. Press $\text{\textcircled{EXE}}$.

- This recalls the value of variable A.



A $\sqrt{\square}$ \square \blacktriangle
B

Example 4: To multiply the contents of variable A by 10
(Continuing from step 2 of Example 1)

$\text{\textcircled{\uparrow}} \text{\textcircled{4}} \text{\textcircled{(A)}} * \text{\textcircled{\times}} 10 \text{\textcircled{EXE}}$



$\sqrt{\square}$ \square \blacktriangle
A*10
80

* Input a variable as shown here: press $\text{\textcircled{\uparrow}}$ and then press the key that corresponds to the desired variable name. To input x as the variable name, you can press $\text{\textcircled{\uparrow}} \text{\textcircled{0}} (x)$ or $\text{\textcircled{\times}}$.

Clearing the Contents of All Memories

Ans memory and variable contents are retained even if you press **AC**, change the calculator app, or turn off the calculator.

Perform the procedure below when you want to clear the contents of all memories.

1. Press **△**, select a calculator app icon, and then press **OK**.
2. Press **≡**, and then select [Reset] > [Variable Memory] > [Yes].

Changing Calculation Result Format

Using the FORMAT Menu

You can use the FORMAT menu that appears when you press  to convert a displayed calculation result to various formats.

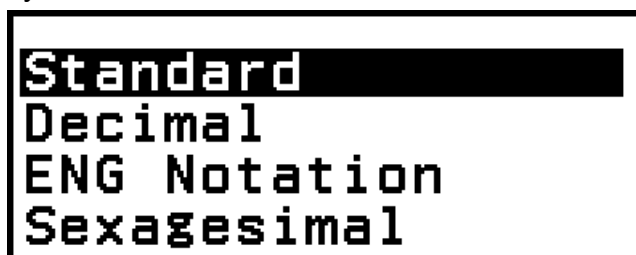

FORMAT Menu List

This menu item:	Converts to this format:
Standard	Standard (Includes fraction, π , $\sqrt{\quad}$ formats.)
Decimal	Decimal
Prime Factor	Prime factorization
Rectangular Coord	Rectangular coordinates
Polar Coord	Polar coordinates
Improper Fraction	Improper fraction
Mixed Fraction	Mixed fraction
ENG Notation	Engineering notation ($a \times 10^n$ format, n = exponent divisible by 3)
Sexagesimal	Degree, minute, second (Sexagesimal)

Note

- The menu items that appear when FORMAT is pressed depend on the currently displayed calculation result. Also, if a calculation result that cannot be converted is displayed, the menu will not appear when you press FORMAT .

Conversion Sample Operation

Example: $3 \div 2 = \frac{3}{2} = 1.5 = 1 \frac{1}{2}$

In this example, we will convert a calculation result displayed as an improper fraction to a decimal value and then to a mixed fraction. Finally, we will cancel the conversion and go back to the original calculation result. (Input/Output: MathI/MathO, Fraction Result: Improp Fraction)

1. Execute the calculation $3 \div 2$.

$3 \div 2 \text{ EXE}$



The calculator display shows the expression $3 \div 2$ in the top left corner. In the bottom right corner, the result is displayed as the improper fraction $\frac{3}{2}$. Above the expression, there are small icons for $\sqrt{\square}$ and \square . A small triangle is in the top right corner.

2. To convert the calculation result to a decimal value, press FORMAT , select [Decimal], and then press EXE .



The calculator display shows the expression $3 \div 2$ in the top left corner. In the bottom right corner, the result is displayed as the decimal value 1.5. Above the expression, there are small icons for $\sqrt{\square}$ and \square . A small triangle is in the top right corner.

3. To convert the calculation result to a mixed fraction, press FORMAT , select [Mixed Fraction], and then press EXE .



The calculator display shows the expression $3 \div 2$ in the top left corner. In the bottom right corner, the result is displayed as the mixed fraction $1 \frac{1}{2}$. Above the expression, there are small icons for $\sqrt{\square}$ and \square . A small triangle is in the top right corner.

4. To cancel conversion, press EXE .
 - This displays the original calculation result from step 1.



The calculator display shows the expression $3 \div 2$ in the top left corner. In the bottom right corner, the result is displayed as the improper fraction $\frac{3}{2}$. Above the expression, there are small icons for $\sqrt{\square}$ and \square . A small triangle is in the top right corner.

Standard and Decimal Conversion

Standard is a format that displays a calculation result in a form that includes a fraction, $\sqrt{\quad}$, or π when possible. Decimal is a format that displays the calculation result as a decimal value.

Note

- Conversion to Standard format that includes $\sqrt{\quad}$ or π is possible when MathI/MathO or MathI/DecimalO is selected for the Input/Output setting on the SETTINGS menu.

You can use the operation below to convert a calculation result to the Standard or Decimal format.

Example: $\pi \div 6 = \frac{1}{6} \pi = 0.5235987756$ (Input/Output: MathI/MathO)

\uparrow $\textcircled{7}$ (π) \div 6 $\textcircled{\text{EXE}}$



$\textcircled{\text{FORMAT}}$ \downarrow
(Select [Decimal].)

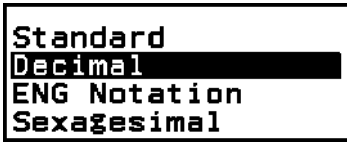

$\textcircled{\text{OK}}$
(Converts to a decimal value.)

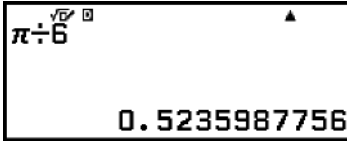

$\textcircled{\text{FORMAT}}$

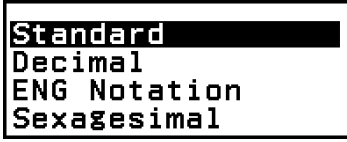

$\textcircled{\text{OK}}$
(Converts to Standard format.)



Important!

- With certain calculation results, selecting [Standard] on the FORMAT menu will not convert the displayed value.



To obtain a decimal value calculation result while MathI/MathO or LineI/LineO is selected

Press \uparrow $\textcircled{\text{EXE}}$ (\approx) instead of $\textcircled{\text{EXE}}$ after inputting a calculation.

Prime Factorization

In the Calculate app, a positive integer no more than 10 digits long can be factored to prime factors.

Example: To perform prime factorization on 1014

1014  

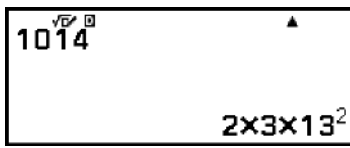
 – [Prime Factor] 

Note

- The types of values described below cannot be factored, even if they have 10 or fewer digits.
 - One of the prime factors of the value is 1,018,081 or greater.
 - Two or more of the prime factors of the value have more than three digits.
- The part that cannot be factored is enclosed in parentheses on the display.

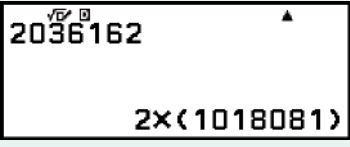

Example: $2036162 = 2 \times (1018081)^*$

*1018081 = 1009^2

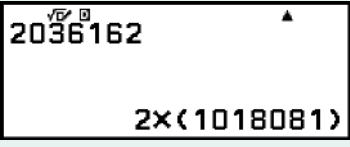
2036162  

 – [Prime Factor] 

Rectangular and Polar Coordinate Conversion

You can convert a complex number calculation result to rectangular coordinates ( – [Rectangular Coord]) or polar coordinates ( – [Polar Coord]). This conversion operation can be performed in either of the following cases.

- While an Equation app higher-order equation solution is displayed (provided that On is selected for the  – [Complex Roots] setting of the Equation app)
- While a Complex app calculation result is displayed

For an actual sample conversion operation, see the sections below.

["Converting a Complex Number Solution to Rectangular or Polar Coordinates" \(page 105\)](#)

["Converting a Complex Number Calculation Result to Rectangular or Polar Coordinates" \(page 111\)](#)

Improper Fraction and Mixed Fraction Conversion

You can convert the currently displayed fraction or decimal value (decimal value that is convertible to a fraction by this calculator) calculation result to a mixed fraction or an improper fraction.

Example 1: $\frac{13}{4} = 3 \frac{1}{4}$

(Input/Output: MathI/MathO, Fraction Result: Improp Fraction)

13 $\frac{1}{4}$ EXE	$\frac{13}{4}$
$\frac{1}{4}$ – [Mixed Fraction]	$3 \frac{1}{4}$
$\frac{1}{4}$ – [Improper Fraction]	$\frac{13}{4}$

Example 2: $3.25 = \frac{13}{4} = 3 \frac{1}{4}$ (Input/Output: LineI/LineO)

3 . 25 EXE	3.25
$\frac{1}{4}$ – [Improper Fraction]	13 J 4
$\frac{1}{4}$ – [Mixed Fraction]	3 J 1 J 4

Engineering Notation

You can convert the exponent part of a displayed calculation result value to a power of ten that is a multiple of 3, and displays the result.

Example: Transform the value 1234 to engineering notation, shifting the decimal mark to the right, and then to the left.

1. Input 1234, and then press EXE.

$\sqrt{x} \square$ 1234 ▲ 1234
--

2. Perform the operation below to enter the ENG Conversion Mode.

$\frac{1}{4}$ – [ENG Notation]	$\sqrt{x} \square$ 1234 ▲ 1.234 $\times 10^3$ \square
--------------------------------	---

- Entering the ENG Conversion Mode converts the calculation result to engineering notation and causes  to appear to its right.
- In the ENG Conversion Mode, you can use \leftarrow and \rightarrow to shift the decimal point of the mantissa.

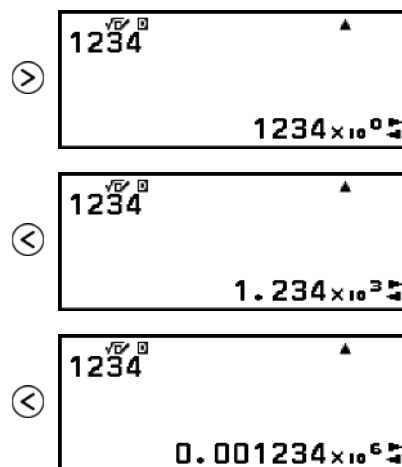

3. To exit the ENG Conversion Mode, press \rightarrow .

- This exits the ENG Conversion Mode and causes  to disappear from the display.

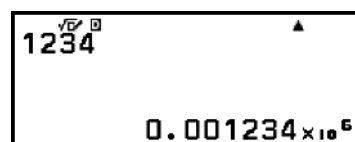

- You can also exit the ENG Conversion Mode by pressing OK or AC .

Note

- Normal calculations are not possible while in the ENG Conversion Mode. To start a new calculation, exit the ENG Conversion Mode.
- Engineering notation can also be displayed using engineering symbols. For details, see "[Engineering Symbols](#)" (page 56).

Sexagesimal Conversion (Degree, Minute, Second Calculations)

You can convert a decimal value calculation result to a sexagesimal value.

Converting a Decimal Value Calculation Result to a Sexagesimal Value

Example: $1.25 = 1^{\circ}15'0''$

1 \odot 25 EXE



FORM – [Sexagesimal]

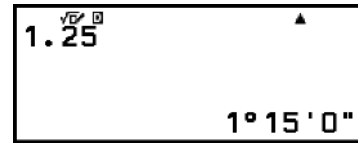

Inputting and Calculating with a Sexagesimal Value

In addition to converting a displayed value to a sexagesimal value, you can also input sexagesimal values and use them in calculations.

The syntax below is for inputting a sexagesimal value:

{degrees} \uparrow \oplus (°) {minutes} \uparrow \oplus (°) {seconds} \uparrow \oplus (°)

Note that you must always input something for the degrees and minutes, even if they are zero.

Example: To perform the calculation $2^\circ 20' 30'' + 9' 30''$. Next, convert the calculation result to a decimal value.

2 \uparrow \oplus (°) 20 \uparrow \oplus (°) 30 \uparrow \oplus (°) \oplus
 0 \uparrow \oplus (°) 9 \uparrow \oplus (°) 30 \uparrow \oplus (°) EXE

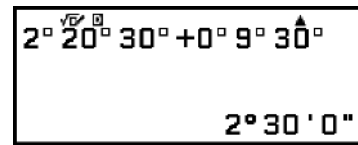

(Convert to a decimal value.)

FORM – [Decimal]

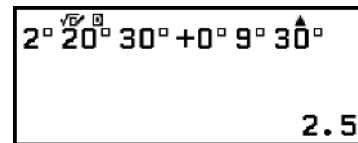

(Return to sexagesimal display.)

FORM – [Sexagesimal]

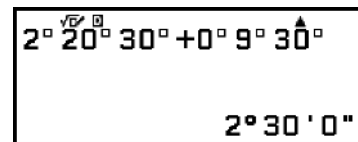

Advanced Calculations

This section describes commands, functions, and symbols that are common to all of the calculator apps. The order used here to present commands, functions, and symbols is the same order in which they are displayed on the CATALOG menu that appears when you press $\text{\textcircled{C}}$.

Note

- There are also calculator app-specific CATALOG menu items, which are not shown here. See the chapter for each calculator app for more information about app-specific menu items.
- Depending on the calculator app you are using and the screen displayed by the calculator app, you may not be able to input some commands, functions, or symbols. Commands, functions, and symbols that cannot be input do not appear on the CATALOG menu.
- The commands, functions, and symbols described here are not available in the Base-N app.

Function Analysis

This section explains commands and functions that you can input after performing the operation: $\text{\textcircled{C}}$ – [Func Analysis].

Derivative(d/dx)

Derivative(d/dx) obtains the approximate differential coefficient at the specified x -coordinate (a) in the input $f(x)$ expression.

Note

- This function can be used with any of the following calculator apps: Calculate, Statistics, Distribution, Spreadsheet, Table, Equation, Inequality, Matrix, Vector, Ratio.

Input Syntax

The input syntax depends on the Input/Output setting on the SETTINGS menu, as shown in the table below.

Input/Output setting	Input Syntax
MathI/MathO or MathI/DecimalO	$\frac{d}{dx}(f(x)) _{x=a}$
LineI/LineO or LineI/DecimalO	$\frac{d}{dx}(f(x), a, tol)^*$

* *tol* specifies tolerance, which becomes 1×10^{-16} when nothing is input for *tol*.

Derivative Calculation Precautions

- When using a trigonometric function in $f(x)$, specify "Radian" as Angle Unit on the SETTINGS menu.
- A smaller *tol* value increases precision, but it also increases calculation time. When specifying *tol*, use a value that is 1×10^{-22} or greater.
- Inaccurate results and errors can be caused by the following:
 - discontinuous points in x values
 - extreme changes in x values
 - inclusion of the local maximum point and local minimum point in x values
 - inclusion of the inflection point in x values
 - inclusion of undifferentiable points in x values
 - differential calculation results approaching zero

Derivative Calculation Example

Determine $f'(\frac{\pi}{2})$ when $f(x) = \sin(x)$ (*tol* specification omitted.)

(Input/Output: MathI/MathO, Angle Unit: Radian)

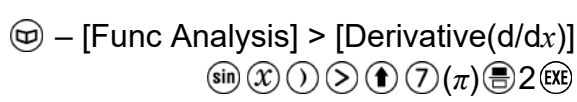
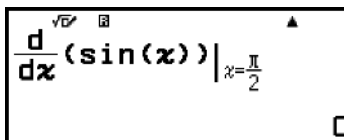
(Input/Output: LineI/LineO, Angle Unit: Radian)

Integration(∫)

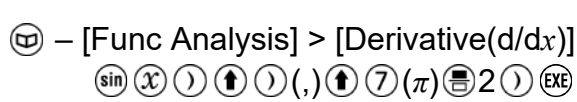
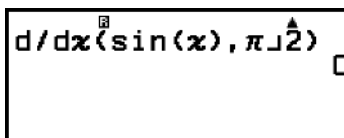
This calculator performs integration using the Gauss-Kronrod method of numerical integration.

Note

- This function can be used with any of the following calculator apps: Calculate, Statistics, Distribution, Spreadsheet, Table, Equation, Inequality, Matrix, Vector, Ratio.

Input Syntax

The input syntax depends on the Input/Output setting on the SETTINGS menu, as shown in the table below.

Input/Output setting	Input Syntax
MathI/MathO or MathI/DecimalO	$\int_a^b f(x)dx$
LineI/LineO or LineI/DecimalO	$\int (f(x), a, b, tol)^*$

* *tol* specifies tolerance, which becomes 1×10^{-10} when nothing is input for *tol*.

Integration Calculation Precautions

- When using a trigonometric function in $f(x)$, specify "Radian" as Angle Unit on the SETTINGS menu.
- A smaller *tol* value increases precision, but it also increases calculation time. When specifying *tol*, use a value that is 1×10^{-22} or greater.
- Depending on the content of $f(x)$, positive and negative values within the region of integration or the region of integration, large error may result in calculated integration values. (Examples: When there are parts with discontinuous points or abrupt change. When the integration interval is too wide.) In such cases, dividing the integration interval into multiple parts and then performing calculations may improve calculation accuracy.

Integration Calculation Example

$$\int (\ln(x), 1, e) = 1 \quad (\text{tol specification omitted.})$$

(Input/Output: MathI/MathO)

⊞ – [Func Analysis] > [Integration(∫)]
 ↑ (log) (ln) (x) () ↓ 1 (∧) ↑ (8) (e) (EXE)

The screenshot shows a calculator interface with the following elements: a function menu icon (⊞), a minus sign, the text "[Func Analysis] > [Integration(∫)]", a series of navigation icons (↑, ⊞, (log), (ln), (x), (), ↓, 1, (∧), ↑, (8), (e), (EXE)), and a display window showing the integral expression $\int_1^e \ln(x) dx$ and the result "1" in the bottom right corner.

(Input/Output: LineI/LineO)

$\text{[Func Analysis]} > \text{[Integration(\int)]}$
 $\text{[ln]}(\text{[x]}) \text{[1]} \text{[e]} \text{[^]} \text{[1]}$
 [EXE]

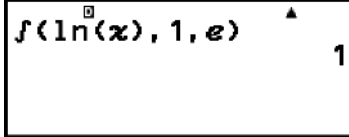

Summation(Σ)

With Σ (, you can obtain the sum of an input $f(x)$ expression for a specific range.

Note

- This function can be used with any of the following calculator apps: Calculate, Statistics, Distribution, Spreadsheet, Table, Equation (except for Solver), Inequality, Matrix, Vector, Ratio.

Input Syntax

The input syntax depends on the Input/Output setting on the SETTINGS menu, as shown in the table below.

Input/Output setting	Input Syntax
MathI/MathO or MathI/DecimalO	$\sum_{x=a}^b (f(x))$
LineI/LineO or LineI/DecimalO	$\Sigma(f(x), a, b)^*$

* a and b are integers that can be specified within the range of $-1 \times 10^{10} < a \leq b < 1 \times 10^{10}$.

Σ Calculation Example

$$\sum_{x=1}^5 (x + 1) = 20$$

(Input/Output: MathI/MathO)

$\text{[Func Analysis]} > \text{[Summation(\Sigma)]}$
 $\text{[x]} \text{[+]} \text{[1]} \text{[v]} \text{[1]} \text{[^]} \text{[5]} \text{[EXE]}$

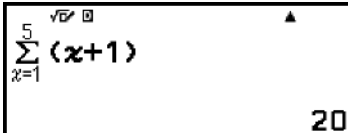

(Input/Output: LineI/LineO)

☰ – [Func Analysis] > [Summation(Σ)]
 $(x) (+) 1 (\uparrow) () (,) 1 (\uparrow) () (,) 5 (\downarrow) \text{EXE}$

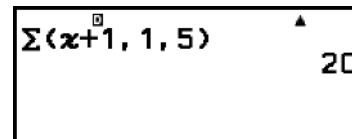

Logarithm(logab), Logarithm(log)

Use $\uparrow \text{log}$ or ☰ – [Func Analysis] > [Logarithm(log)] to input $\log_a b$ as $\log(a, b)$. Base 10 is the initial default setting if you do not input anything for a .

Example 1: $\log_{10} 1000 = \log 1000 = 3$

$\uparrow \text{log}^2 (\text{log}) 1000 (\downarrow) \text{EXE}$

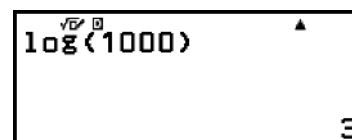

Example 2: $\log_2 16 = 4$

$\uparrow \text{log}^2 (\text{log}) 2 (\uparrow) (,) 16 (\downarrow) \text{EXE}$

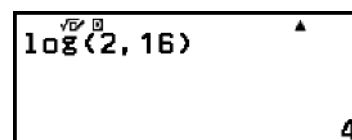

The log^2 key (or ☰ – [Func Analysis] > [Logarithm(logab)]) also can be used for input, but only while MathI/MathO or MathI/DecimalO is selected for Input/Output on the SETTINGS menu. In this case, you must input a value for the base.

Example 3: $\log_2 16 = 4$

$\text{log}^2 2 > 16 \text{EXE}$

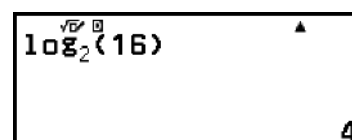

Natural Logarithm

Use $\uparrow \text{log}^n (\text{ln})$ or ☰ – [Func Analysis] > [Natural Logarithm] to input "ln".

Example: $\ln 90 (= \log_e 90) = 4.49980967$

$\uparrow \text{log}^n (\text{ln}) 90 (\downarrow) \text{EXE}$

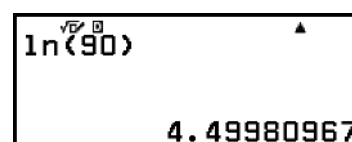

Probability

This section explains commands and functions that you can input after performing the operation: ☰ – [Probability].

%

Inputting a value followed by % command causes the input value to become a percent.

Note

- You cannot input % with the Complex app.

Example 1: $150 \times 20\% = 30$

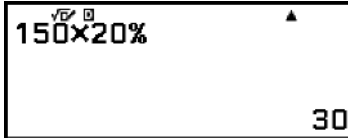
$$\text{Ⓜ} - [\text{Probability}] > [\%] \quad 150 \text{ⓧ} 20 \text{Ⓜ} \quad \text{EXE}$$

A calculator screen showing the calculation 150 x 20% = 30. The display shows '150x20%' and the result '30'.

Example 2: Calculate what percentage of 880 is 660. (75%)

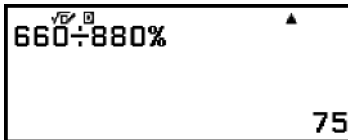
$$\text{Ⓜ} - [\text{Probability}] > [\%] \quad 660 \text{Ⓢ} 880 \text{Ⓜ} \quad \text{EXE}$$

A calculator screen showing the calculation 660 ÷ 880 = 75%. The display shows '660÷880%' and the result '75'.

Example 3: Discount 3500 by 25%. (2625)

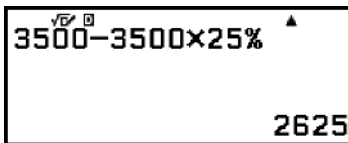
$$\text{Ⓜ} - [\text{Probability}] > [\%] \quad 3500 \text{Ⓜ} - 3500 \text{ⓧ} 25 \text{Ⓜ} \quad \text{EXE}$$

A calculator screen showing the calculation 3500 - 3500 x 25% = 2625. The display shows '3500-3500x25%' and the result '2625'.

Factorial(!)

This function obtains the factorials of a value that is zero or a positive integer.

Example: $(5 + 3)! = 40320$

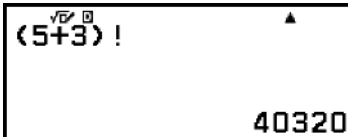
$$\text{Ⓜ} - [\text{Probability}] > [\text{Factorial(!)}] \quad (5+3) \text{Ⓜ} \quad \text{EXE}$$

A calculator screen showing the calculation (5+3)! = 40320. The display shows '(5+3)!' and the result '40320'.

Permutation(P), Combination(C)

Permutation (nPr) and combination (nCr) functions.

Example: To determine the number of permutations and combinations possible when selecting four people from a group of 10

Permutations:

$$\text{[Probability]} > [\text{Permutation}(P)]$$

10
4 **EXE**



Combinations:

$$\text{[Probability]} > [\text{Combination}(C)]$$

10
4 **EXE**



Random Number

This function generates a pseudo random number in the range of 0.000 to 0.999. The result is displayed as a fraction when MathI/MathO is selected for Input/Output on the SETTINGS menu.

Note

- Ran# cannot be input with Solver of the Equation app.

Example: To obtain random three-digit integers

$$\text{[Probability]} > [\text{Random Number}]$$

1000
EXE



(The result differs with each execution.)

Random Integer

This function generates a pseudo random integer between a specified start value and end value.

Note

- RanInt# cannot be input with Solver of the Equation app.

Example: To generate random integers in the range of 1 to 6

$$\text{[Probability]} > [\text{Random Integer}]$$

1 **↑** **↓** (,) 6 **↓**
EXE

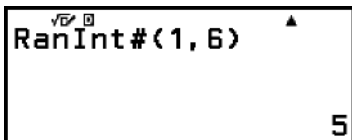

(The result differs with each execution.)

Numeric Calculations

This section explains commands and functions that you can input after performing the operation: $\text{[2nd]} - \text{[Numeric Calc]}$.

Absolute Value

When you are performing a real number calculation, this function simply obtains the absolute value.

Example: $|2 - 7| = \text{Abs}(2 - 7) = 5$
(Input/Output: MathI/MathO)

$$\text{[2nd]} - \text{[Numeric Calc]} > \text{[Absolute Value]} \\ 2 \ominus 7 \text{EXE}$$

(Input/Output: LineI/LineO)

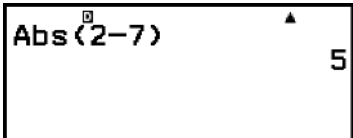
$$\text{[2nd]} - \text{[Numeric Calc]} > \text{[Absolute Value]} \\ 2 \ominus 7 \text{)} \text{EXE}$$

Round Off

Using the Round Off function (Rnd) causes decimal fraction values of the argument to be rounded in accordance with the current Number Format setting. For example, the internal and displayed result of $\text{Rnd}(10 \div 3)$ is 3.333 when the Number Format setting is Fix 3. Using the Norm 1 or Norm 2 setting cause the argument to be rounded off at the 11th digit of the mantissa part.

Example: To perform the following calculations when Fix 3 is selected for the number of display digits: $10 \div 3 \times 3$ and $\text{Rnd}(10 \div 3) \times 3$
(Input/Output: MathI/DecimalO, Number Format: Fix 3)

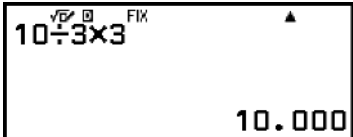
$$10 \div 3 \times 3 \text{EXE}$$

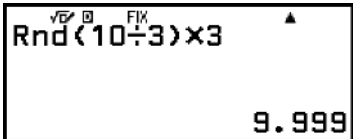
$$\text{[2nd]} - \text{[Numeric Calc]} > \text{[Round Off]} \\ 10 \div 3 \text{)} \times 3 \text{EXE}$$

Angle Unit, Polar/Rectangular Coordinate, Sexagesimal

This section explains commands, functions, and symbols that you can input after performing the operation: $\text{[Angle/Coord/Sexa]}$ – [Angle/Coord/Sexa].

Degrees, Radians, Gradians

These functions specify the angle unit.

$^{\circ}$ specifies degree, $^{\text{r}}$ radian, and $^{\text{g}}$ gradian.

You can input each function using the menu items below.

$\text{[Angle/Coord/Sexa]}$ > [Degrees]

$\text{[Angle/Coord/Sexa]}$ > [Radians]

$\text{[Angle/Coord/Sexa]}$ > [Gradians]

Example: $\pi/2$ radians = 90° (Angle Unit: Degree)

$\text{[Angle/Coord/Sexa]}$ > [Radians]

\uparrow [7] $\text{[}\pi\text{]}$ $\text{[}\div\text{]}$ [2] [>]
 $\text{[Angle/Coord/Sexa]}$ > [Radians]

$\sqrt{\square}$ \square

$\frac{\pi}{2}^{\text{r}}$

90

Rect to Polar, Polar to Rect

"Pol(" converts rectangular coordinates to polar coordinates, while "Rec(" converts polar coordinates to rectangular coordinates.

$$\text{Pol}(x, y) = (r, \theta) \qquad \text{Rec}(r, \theta) = (x, y)$$

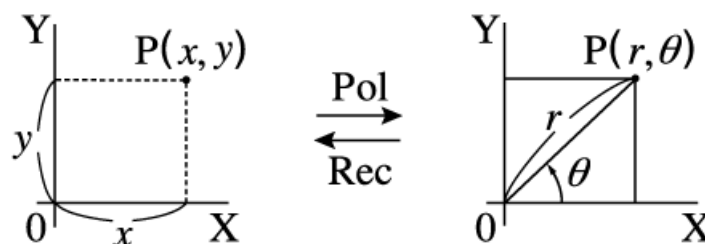

- Specify the Angle Unit on the SETTINGS menu before performing calculations.
- The calculation result for r and θ and for x and y are each stored respectively to variables x and y .
- Calculation result θ is displayed in the range of $-180^{\circ} < \theta \leq 180^{\circ}$.

Note

- Pol(and Rec(can be used on the calculation screen of the calculator apps below.
Calculate, Statistics, Matrix, Vector

Example 1: To convert rectangular coordinates ($\sqrt{2}$, $\sqrt{2}$) to polar coordinates (Input/Output: MathI/MathO, Angle Unit: Degree)

Ⓜ – [Angle/Coord/Sexa] > [Rect to Polar]
 $\sqrt{2}$ > \uparrow > \circ > $\sqrt{2}$ > \circ > EXE

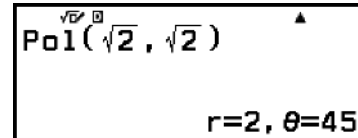

Example 2: To convert polar coordinates ($\sqrt{2}$, 45°) to rectangular coordinates (Input/Output: MathI/MathO, Angle Unit: Degree)

Ⓜ – [Angle/Coord/Sexa] > [Polar to Rect]
 $\sqrt{2}$ > \uparrow > \circ > $(,)$ > 45 > \circ > EXE

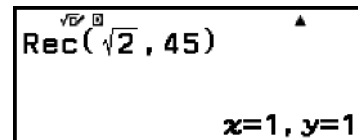

Degrees, Minutes, Seconds

You can use the keys or the menu item below to input the sexagesimal symbol ($^{\circ}$).

\uparrow \oplus ($^{\circ}$ $''$ $'''$)

Ⓜ – [Angle/Coord/Sexa] > [Degr Mins Secs]

For details, see "[Sexagesimal Conversion \(Degree, Minute, Second Calculations\)](#)" (page 44).

Hyperbolic, Trigonometric

This section explains hyperbolic and trigonometric functions.

Hyperbolic Functions

Hyperbolic functions can be input using the menu items below.

Ⓜ – [Hyperbolic/Trig] > [sinh], [cosh], [tanh], [\sinh^{-1}], [\cosh^{-1}], or [\tanh^{-1}]

The angle unit setting does not affect calculations.

Example: $\sinh 1 = 1.175201194$

Ⓜ – [Hyperbolic/Trig] > [sinh] 1 > \circ > EXE

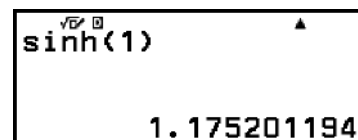

Trigonometric Functions

Trigonometric functions can be input using the keys or menu items below.

Key	Menu Item
\sin	$\text{[Hyperbolic/Trig]} > [\sin]$
\cos	$\text{[Hyperbolic/Trig]} > [\cos]$
\tan	$\text{[Hyperbolic/Trig]} > [\tan]$
$\uparrow \sin(\sin^{-1})$	$\text{[Hyperbolic/Trig]} > [\sin^{-1}]$
$\uparrow \cos(\cos^{-1})$	$\text{[Hyperbolic/Trig]} > [\cos^{-1}]$
$\uparrow \tan(\tan^{-1})$	$\text{[Hyperbolic/Trig]} > [\tan^{-1}]$

Specify the Angle Unit on the SETTINGS menu before performing calculations.

Example: $\sin 30 = \frac{1}{2}$ (Angle Unit: Degree)



Engineering Symbols

Your calculator supports the use of 11 engineering symbols (m, μ , n, p, f, k, M, G, T, P, E) that you can use for input of value or for calculation result display.

- Engineering symbols can be input after performing the operation: $\text{[Hyperbolic/Trig]} - [\text{Engineer Symbol}]$.
- To display calculation results with engineering symbols, perform the following operation: $\text{[Menu]} - [\text{Calc Settings}] > [\text{Engineer Symbol}] > [\text{On}]$.

Example Input and Calculations Using Engineering Symbols

Example 1: To input 500k
(Engineer Symbol: On)

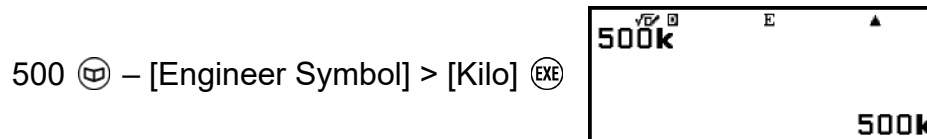

Example 2: To calculate 999k (kilo) + 25k (kilo) = 1.024M (Mega) = 1024k (kilo) = 1024000
 (Engineer Symbol: On)

999 [ENG] – [Engineer Symbol] > [Kilo] [K]
 25 [ENG] – [Engineer Symbol] > [Kilo] [K] [EXE]

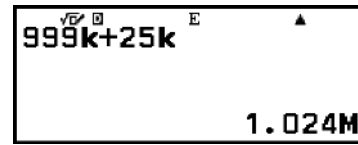

[FORMAT] – [ENG Notation]
 (Enters the ENG Conversion Mode.)

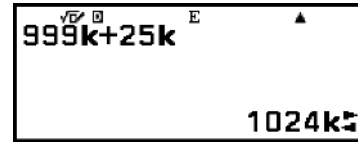

[>]

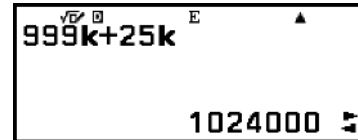

[<]

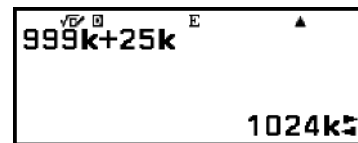

- Pressing [>] , [OK] , or [AC] exits the ENG Conversion Mode and causes [ENG] to disappear from the display. To start a new calculation, exit the ENG Conversion Mode.
- For details about the ENG Conversion Mode, see "[Engineering Notation](#)" (page 43).

Scientific Constants

Your calculator comes with 47 built-in scientific constants. The values are based on CODATA (2018) recommended values.

Example: To input the scientific constant c (speed of light in vacuum), and display its value

1. Press [2ND] , select [Sci Constants], and then press [OK] .

- This displays a menu of scientific constant categories*.

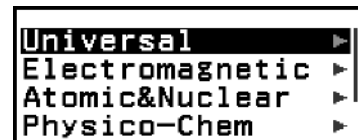

2. Select [Universal], and then press [OK] .

- This displays a menu of scientific constants in the Universal category.

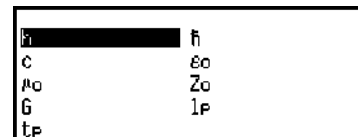

3. Select [c], and then press OK .

c

4. Press EXE .

c
299792458

* The table below shows the scientific constants included in each category.

Category	Scientific Constants
Universal	$h, \hbar, c, \epsilon_0, \mu_0, Z_0, G, I_P, t_P$
Electromagnetic	$\mu_N, \mu_B, e, \Phi_0, G_0, K_J, R_K$
Atomic&Nuclear	$m_p, m_n, m_e, m_\mu, a_0, \alpha, r_e, \lambda_C, \gamma_p, \lambda_{Cp}, \lambda_{Cn}, R_\infty, \mu_p, \mu_e, \mu_n, \mu_\mu, m_\tau$
Physico-Chem	$m_u, F, N_A, k, V_m, R, c_1, c_2, \sigma$
Adopted Values	$g_n, \text{atm}, R_{K-90}, K_{J-90}$
Other	t

Unit Conversions

You can use the unit conversion commands to convert from one unit of measurement to another. Conversion formula data is based on the "NIST Special Publication 811 (2008)".

Example: To convert 5 cm into inches (Input/Output: LineI/LineO)

1. Input the value to be converted.

5

2. Press UNIT , select [Unit Conversions], and then press OK .

- This displays a menu of unit conversion categories*.

Length
Area
Volume
Mass

3. Select [Length], and then press OK .

- This displays a menu of conversion commands in the Length category.



4. Select [cm to in] (the centimeters-to-inches conversion command) and then press **OK**.



5. Press **EXE**.

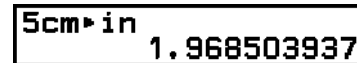

* The table below shows the unit conversion commands included in each category.

Category	Unit Conversion Commands
Length	in to cm, cm to in, ft to m, m to ft, yd to m, m to yd, mile to km, km to mile, n mile to m, m to n mile, pc to km, km to pc
Area	acre to m ² , m ² to acre
Volume	gal(US) to L, L to gal(US), gal(UK) to L, L to gal(UK)
Mass	oz to g, g to oz, lb to kg, kg to lb
Velocity	km/h to m/s, m/s to km/h
Pressure	atm to Pa, Pa to atm, mmHg to Pa, Pa to mmHg, kgf/cm ² to Pa, Pa to kgf/cm ² , lbf/in ² to kPa, kPa to lbf/in ²
Energy	kgf · m to J, J to kgf · m, J to cal ₁₅ , cal ₁₅ to J
Power	hp to kW, kW to hp
Temperature	°F to °C, °C to °F

Others

Functions and symbols that can be input with the calculator keys can also be input using the [Other] menu. Use $\text{Ⓜ} - [\text{Other}]$ to display the function and symbol menu. For example, to input Ans, you could either press $\text{Ⓜ}(\text{Ans})$ or perform the following operation: $\text{Ⓜ} - [\text{Other}] > [\text{Ans}]$.

The table below shows the [Other] menu item that corresponds to each key operation.

Menu Item	Key
Ans	$\text{Ⓜ}(\text{Ans})$
π	$\text{Ⓜ}(\uparrow) 7 (\pi)$
e	$\text{Ⓜ}(\uparrow) 8 (e)$
$\sqrt{\quad}$	$\text{Ⓜ}(\sqrt{\quad})$
$^x\sqrt{\quad}$	$\text{Ⓜ}(\uparrow) \text{Ⓜ}(\sqrt{\quad}) \text{Ⓜ}(\sqrt[2]{\quad})$
-1 *1	$\text{Ⓜ}(\uparrow) \text{Ⓜ}(\square^{\square}) (\square^{-1})$
2 *2	$\text{Ⓜ}(\square^2)$
$\wedge(\quad)$	$\text{Ⓜ}(\square^{\square})$
- *3	$\text{Ⓜ}(\uparrow) \text{Ⓜ}(\ominus) ((-))$
,	$\text{Ⓜ}(\uparrow) \text{Ⓜ}(\text{Ⓜ}) (,)$
($\text{Ⓜ}(\text{Ⓜ})$
)	$\text{Ⓜ}(\text{Ⓜ})$

*1 Reciprocal

*2 Square

*3 Minus sign

Registering and Using Defining Equations for $f(x)$ and $g(x)$

Registering and Using Defining Equations for $f(x)$ and $g(x)$

Your calculator includes "f(" and "g(" functions that you can use after registering defining equations for them. For example, after registering $f(x) = x^2 + 1$ as a defining equation for the "f(" function, you can calculate $f(0) = 1$ and $f(5) = 26$.

Pressing f(x) displays a menu for registering the defining equation of $f(x)$ or $g(x)$, and for inputting "f(" or "g(".

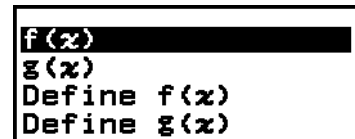

Note

- The defining equations of $f(x)$ and $g(x)$ are also used by $f(x)$ and $g(x)$ in the Table app. For information about the Table app, see "[Creating a Number Table](#)" (page 95).

Registering a Defining Equation

Example 1: To register $f(x) = x^2 + 1$

1. Press MODE , select the Calculate app icon, and then press OK .
2. Press f(x) , and then select [Define $f(x)$].
 - This displays the $f(x)$ equation registration screen.

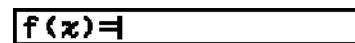

3. Input $x^2 + 1$.

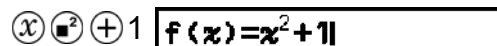

4. Press EXE .
 - This registers the expression you input, and the screen that was shown before you pressed f(x) in step 2 of this procedure re-appears.

Note

- A defining equation can be registered from any calculator app except Distribution, Equation (Simul Equation / Polynomial), Inequality, Base-N, Ratio and Math Box.

However, depending on the screen displayed by the calculator app (for example, if a menu screen is displayed), the menu may not appear when you press $\text{f}(x)$.

Performing a Calculation by Assigning a Value to the Registered Defining Equation

Example 2: To assign the value $x = 3$ to $f(x)$, which you registered in

Example 1

(Continuing from Example 1)

1. Press $\text{f}(x)$, and then select $[f(x)]$.

- This inputs "f".

f(

2. Assign a value of 3 and then execute the calculation.

3) EXE $\text{f}(3)$ 10

Registering a Composite Function

Example 3: To insert $f(x)$ defined in Example 1 into $g(x)$ in order to register

$$g(x) = f(x) \times 2 - x$$

(Continuing from Example 1)

1. Press $\text{f}(x)$, and then select $[Define\ g(x)]$.

- This displays the $g(x)$ equation registration screen.

g(x)=

2. Input $f(x) \times 2 - x$.

$\text{f}(x)$ * EXE (x)) (x) 2 - (x) $g(x) = f(x) \times 2 - x$

- * Pressing $\text{f}(x)$ while the $g(x)$ equation registration screen is displayed, the only menu item that appears is $[f(x)]$. In the same way, pressing $\text{f}(x)$ while the $f(x)$ equation registration screen is displayed, the only menu item that appears is $[g(x)]$.

3. Press EXE.

- This registers the equation you input and returns to the screen displayed before you started this operation with step 1.

Note

- The operation for assigning a value to x of $g(x)$ and calculating the result is the same as that under "[Performing a Calculation by Assigning a Value to the Registered Defining Equation](#)" (page 62). However, note that instead of selecting $[f(x)]$ in step 1, you should select $[g(x)]$.

- In the operation of Example 3, you input $f(x)$ into the defining equation of $g(x)$. Conversely, you can also input $g(x)$ into the $f(x)$ defining equation. However, do not have $g(x)$ input into $f(x)$, and $f(x)$ input into $g(x)$ at the same time. If you do, a Circular ERROR will occur when you perform a calculation using $f(x)$ or $g(x)$.

Data Retention

Performing any one of the operations below causes the defining equations registered to $f(x)$ and $g(x)$ to be deleted.

- Pressing ⏏
- Using the SETTINGS menu to switch the Input/Output setting between MathI*¹ and LineI*².
 - *¹ MathI/MathO or MathI/DecimalO
 - *² LineI/LineO or LineI/DecimalO
- Executing $\text{⊞} - [\text{Reset}] > [\text{Settings \& Data}]$ or $\text{⊞} - [\text{Reset}] > [\text{Initialize All}]$

Using QR Code Functions

Using QR Code Functions

Your calculator can display QR Code symbols that can be read by a smart device.

Important!

- The operations in this section assume that the smart device being used has a QR Code reader that can read multiple QR Code symbols, and it can connect to the Internet.
- Scanning a QR Code displayed by this calculator with a smart device will cause the smart device to access the CASIO website.

Note

- QR Code appears on the display whenever you press \uparrow (x) (QR) while any one of the screens below is displayed.
 - HOME screen
 - SETTINGS menu screen
 - Error screens
 - Calculation result screens in any calculator app
 - Table screens in any calculator app
 - Spreadsheet app screen
- For details, visit the CASIO website (<https://wes.casio.com>).

Displaying a QR Code

Example: To display the QR Code for a calculation result in the calculator's Calculate app and scan it with a smart device

1. In the Calculate app, perform some calculation.
2. Press \uparrow (x) (QR) to display the QR Code.
 - The numbers in the lower right corner of the display show the current QR Code number and the total number of QR Code symbols. To display the next QR Code, press \downarrow or OK .

Note

- To return to a previous QR Code, press \downarrow or OK as many times as required to scroll forward until it appears.

3. Use a smart device to scan the QR Code on the calculator display.
 - For information about how to scan a QR Code, refer to the user documentation of the QR Code reader you are using.

If You Experience Difficulty Scanning a QR Code

While the QR Code is displayed, use ⏪ and ⏩ to adjust the display contrast of the QR Code. This contrast adjustment affects QR Code displays only.

Important!

- Depending on the smart device and/or QR Code reader app being used, you may experience problems scanning the QR Code symbols produced by this calculator.
- When the "QR Code" setting on the SETTINGS menu is "Version 3", the calculator apps that can display QR Code symbols are limited. If you try to display a QR Code in an app that does not support QR Code display, the message "Not Supported (Version 3)" will appear. However, the QR Code produced by this setting is easier to scan with a smart device.
- For more information, visit the CASIO website (<https://wes.casio.com>).

Using Calculator Apps

Statistical Calculations

The Statistics app calculates various statistical values based on single-variable (x) or paired-variable (x, y) data.

General Procedure for Performing a Statistical Calculation

1. Press \odot , select the Statistics app icon, and then press OK .
2. On the menu that appears, select [1-Variable] (single-variable) or [2-Variable] (paired-variable), and then press OK .
 - This displays the Statistics Editor.

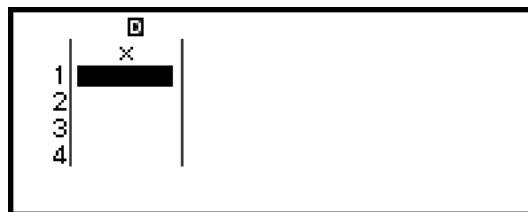

Single-variable

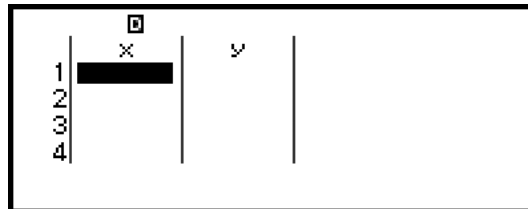

Paired-variable

3. Display the Freq (frequency) column as needed.
 - For details, see ["Freq \(Frequency\) Column" \(page 67\)](#).
4. Input data.
 - For details, see ["Inputting Data with Statistics Editor" \(page 67\)](#).
5. After you finish inputting data, press OK .
 - This causes the menu below to appear.



Single-variable



Paired-variable

6. Select the menu item for the operation you want to perform.
 - Select [1-Var Results], [2-Var Results], or [Reg Results] to see a list of calculation results based on the data you entered. For details, see ["Displaying Statistical Calculation Results" \(page 70\)](#).
 - To display a statistical calculation screen for performing calculations based on the input data, select [Statistics Calc]. For details, see ["Using Statistical Calculation Screen" \(page 74\)](#).

Note

- To return to the Statistics Editor from a statistical calculation screen, press AC and then ↩ .

Inputting Data with Statistics Editor

Statistics Editor displays one, two, or three columns: single-variable (x), single-variable and frequency (x , Freq), paired-variable (x , y), paired-variable and frequency (x , y , Freq). The number of data rows that can be input depends on the number of columns: 160 rows for one column, 80 rows for two columns, 53 rows for three columns.

Important!

- All data currently input in the Statistics Editor is deleted whenever you perform any of the operations below.
 - Switching the statistical calculation type between single-variable and paired-variable
 - Changing the Frequency setting on the TOOLS menu
- Statistical calculations can take considerable time when there are a large number of data items.

Freq (Frequency) Column

If you turn on the Frequency setting on the TOOLS menu, a column labeled "Freq" will also be included on the Statistics Editor. You can use the Freq column to specify the frequency (the number of times the same sample appears in the data group) of each sample value.

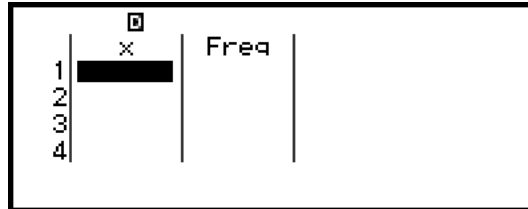

Single-variable

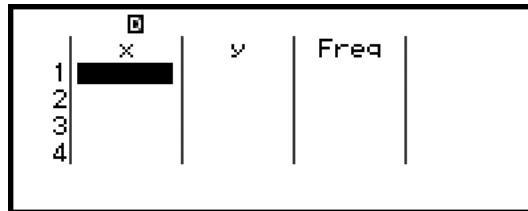

Paired-variable

To display the Freq column

1. While the Statistics Editor is displayed, press \odot and then select [Frequency] > [On].
2. Press AC to return to the Statistics Editor.

To hide the Freq column

1. While the Statistics Editor is displayed, press \odot and then select [Frequency] > [Off].
2. Press AC to return to the Statistics Editor.

Rules for Inputting Sample Data on the Statistics Editor

Data you input is inserted into the cell where the cursor is located. Use the cursor keys to move the cursor between cells.

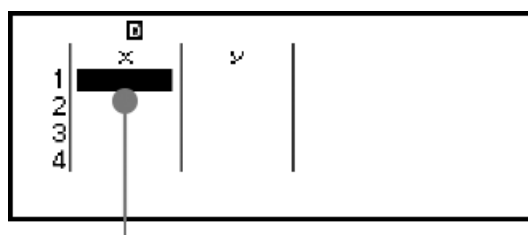

Cursor

After inputting a value, press EXE . This registers the value and displays up to six of its digits in the cell.

Example 1: To select paired-variable and input the following data: (170, 66), (179, 75), (173, 68)

1. Press \odot , select the Statistics app icon, and then press OK .
2. Select [2-Variable], and then press OK .

	x	y
1		
2		
3		
4		

3. Use the operation below to input data.

170 EXE 179 EXE 173 EXE V >
 66 EXE 75 EXE 68 EXE

	x	y
1	170	66
2	179	75
3	173	68
4		

Note

- On the Statistics Editor, you can store the value in a cell to a variable. For example, performing the following operation while the screen in step 3 is displayed above will store 68 to variable A: ^ Z = $\text{[A=]} > \text{[Store]}$. For details about variables, see "[Variables \(A, B, C, D, E, F, x, y, z\)](#)" (page 36).

Editing Sample Data

To replace the data in a cell

On the Statistics Editor, move the cursor to the cell containing the data you want to edit, input the new data, and then press EXE .

To delete a row

On the Statistics Editor, move the cursor to the row you want to delete and then press C .

To insert a row

- On the Statistics Editor, move the cursor to the row that will be under the row you will insert.
- Perform the following operation: O = $\text{[Edit]} > \text{[Insert Row]}$.

To delete all Statistics Editor contents

On the Statistics Editor, perform the following operation: O = $\text{[Edit]} > \text{[Delete All]}$.

Sorting Data

You can sort Statistics Editor data in ascending or descending order on its x , y , or Freq-column values.

Important!

- Note that after you change the data sort sequence, you will not be able to return it to its original sequence.

Example 2: To sort the data input in **Example 1 (page 68)** in ascending order on the x column, and then in descending order on the y column

1. Use the procedure in Example 1 to input the data.

	x	y
1	170	66
2	179	75
3	173	68
4		

2. Sort the data in ascending order on the x column.

\odot – [Sort] > [x Ascending]

	x	y
1	170	66
2	173	68
3	179	75
4		

170

3. Sort the data in descending order on the y column.

\odot – [Sort] > [y Descending]

	x	y
1	179	75
2	173	68
3	170	66
4		

75

Displaying Statistical Calculation Results

Displaying Single-Variable Statistical Calculation Results

The 1-Var Results screen shows a list of various statistical values (such as mean and population standard deviation) calculated based on single-variable data. This section describes the operation required to display the 1-Var Results screen.

Example 3: To input the data below and display single-variable statistical calculation results

x	1	2	3	4	5	6	7	8	9	10
Freq	1	2	1	2	2	2	3	4	2	1

- Press \odot , select the Statistics app icon, and then press \odot .
- Select [1-Variable], and then press \odot .
 - This displays the Statistics Editor.
- Press \odot and then select [Frequency] > [On].
 - Press \odot to return to the Statistics Editor.
- Input data into the x -column.

1 \odot 2 \odot 3 \odot 4 \odot 5 \odot 6 \odot 7 \odot 8 \odot 9 \odot 10 \odot

	x	Freq
8	8	1
9	9	1
10	10	1
11		

5. Input data into the Freq column.

\odot \odot

x	Freq
7	3
8	4
9	2
10	1

6. Press \odot .

1-Var Results
Statistics Calc

7. Select [1-Var Results], and then press \odot .

- This displays the 1-Var Results screen.

\bar{x}	=5.95
Σx	=119
Σx^2	=837
$\sigma^2 x$	=6.4475
σx	=2.539192785
$s^2 x$	=6.786842105

\odot (or \odot)

s_x	=2.605156829
n	=20
$\min(x)$	=1
Q_1	=4
Med	=6.5
Q_3	=8

\odot (or \odot)

$\max(x)$	=10
-----------	-----

- For the meanings of the variables shown on the 1-Var Results screen, see the ["List of Statistical Value Variables and Statistical Calculation Functions"](#) (page 77).

8. Press \odot or \odot to return to the Statistics Editor.

Displaying Paired-Variable Statistical Calculation Results

The 2-Var Results screen shows a list of various statistical values (such as mean and population standard deviation) calculated based on paired-variable data. This section describes the operation required to display the 2-Var Results screen.

Example 4: To input the data below and display paired-variable statistical calculation results

x	1.0	1.2	1.5	1.6	1.9	2.1	2.4	2.5	2.7	3.0
y	1.0	1.1	1.2	1.3	1.4	1.5	1.6	1.7	1.8	2.0

- Press \odot , select the Statistics app icon, and then press \odot .
- Select [2-Variable], and then press \odot .
 - This displays the Statistics Editor.
- Input data into the x -column.

1 EXE 1 \cdot 2 EXE 1 \cdot 5 EXE 1 \cdot 6 EXE 1 \cdot 9 EXE
 2 \cdot 1 EXE 2 \cdot 4 EXE 2 \cdot 5 EXE 2 \cdot 7 EXE 3 EXE

	x	y
8	2.5	0
9	2.7	0
10	3	0
11		

4. Input data into the y -column.

V > 1 EXE 1 \cdot 1 EXE 1 \cdot 2 EXE 1 \cdot 3 EXE 1 \cdot 4 EXE
 1 \cdot 5 EXE 1 \cdot 6 EXE 1 \cdot 7 EXE 1 \cdot 8 EXE 2 EXE

	x	y
8	2.5	1.7
9	2.7	1.8
10	3	2
11		

5. Press OK .

2-Var Results
Reg Results \blacktriangleright
Statistics Calc \blacktriangleright

6. Select [2-Var Results], and then press OK .

- This displays the 2-Var Results screen.

Σx	=1.99
Σx^2	=19.9
Σx^3	=43.57
$\sigma^2 x$	=0.3969
σx	=0.63
$s^2 x$	=0.441

V (or V)

Σxy	=0.6640783086
n	=10
\bar{y}	=1.46
Σy	=14.6
Σy^2	=22.24
$\sigma^2 y$	=0.0924

V (or V)

σy	=0.3039736831
$s^2 y$	=0.1026666667
\bar{y}	=0.3204163958
Σxy	=30.96
Σx^3	=102.451
$\Sigma x^2 y$	=71.244

V (or V)

Σx^4	=253.5541
$\text{min}(x)$	=1
$\text{max}(x)$	=3
$\text{min}(y)$	=1
$\text{max}(y)$	=2

- For the meanings of the variables shown on the 2-Var Results screen, see the ["List of Statistical Value Variables and Statistical Calculation Functions"](#) (page 77).

7. Press 2nd or AC to return to the Statistics Editor.

Displaying Regression Calculation Results

The Reg Results screen displays a list of regression calculation results (coefficients of regression equations) based on paired-variable data. This section describes the operation required to display the Reg Results screen.

Example 5: To use the paired-variable data input in [Example 4 \(page 71\)](#) and display the results of the two regression calculations shown below

- The regression equation " $y = a + bx$ " coefficients (a , b), and the correlation coefficient (r) when linear regression is performed on the data
- The regression equation " $y = a + bx + cx^2$ " coefficients (a , b , c) when quadratic regression is performed on the data

Note

- For information about regression calculation types supported by the Statistics app, see the ["Supported Regression Type List" \(page 74\)](#).

1. Perform steps 1 through 5 of the procedure under [Example 4 \(page 71\)](#).

2. Select [Reg Results], and then press **OK**.
- This displays the regression type menu.

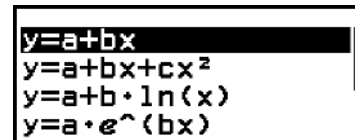

3. Select [$y=a+bx$], and then press **OK**.
- This displays the linear regression Reg Results screen.

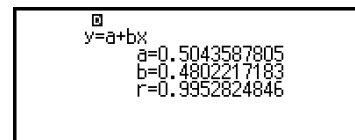

4. Press **↵** or **AC** to return to the Statistics Editor.

5. Press **OK**, and then select [Reg Results] > [$y=a+bx+cx^2$].

- This displays quadratic regression Reg Results screen.

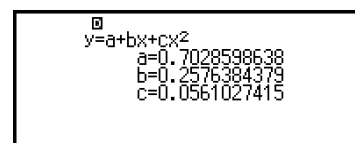

6. Press **↵** or **AC** to return to the Statistics Editor.

- For the meanings of the variables shown on the Reg Results screen, see the ["List of Statistical Value Variables and Statistical Calculation Functions" \(page 77\)](#).

Supported Regression Type List

Regression Type	Regression Equation (regression type menu item)
Linear Regression	$y = a + bx$
Quadratic Regression	$y = a + bx + cx^2$
Logarithmic Regression	$y = a + b \cdot \ln(x)$
<i>e</i> exponential Regression	$y = a \cdot e^{(bx)}$
<i>ab</i> exponential Regression	$y = a \cdot b^x$
Power Regression	$y = a \cdot x^b$
Inverse Regression	$y = a + b/x$

Using Statistical Calculation Screen

You can use the statistical calculation screen to recall individual statistical values and use the values in calculations.



Screen without calculation expression input

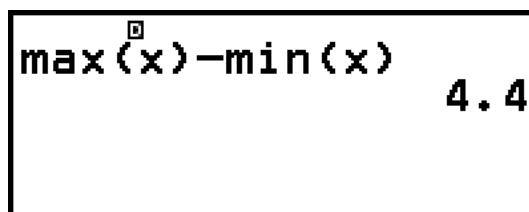

Example calculation

To recall a statistical value, use a variable representing the statistical value you want to recall (for example, \bar{x} , x population standard deviation: σ_x , x maximum value: $\max(x)$, and so on). For more information about these variables, see the ["List of Statistical Value Variables and Statistical Calculation Functions"](#) (page 77).

Displaying a Statistical Calculation Screen

Single-variable

1. While the Statistics Editor is displayed, press OK .
2. On the menu that appears, select [Statistics Calc] and then press OK .



Paired-variable

1. While the Statistics Editor is displayed, press OK .
2. On the menu that appears, select [Statistics Calc] and then press OK .
 - This displays the regression type menu (see the "[Supported Regression Type List](#)" (page 74)).

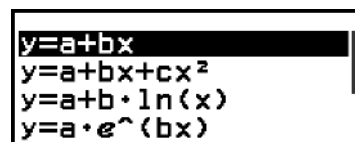

3. On the menu, select the regression type you want and then press OK .



- In the example above, use the displayed menu to select [$y=a+bx$] (Linear regression).

To return to the Statistics Editor from a statistical calculation screen

Press AC , and then 2nd .

Calculation Example Using the Statistical Calculation Screen

Example 6: To determine the sum of the sample data (Σx) and mean (\bar{x}) of the single-variable data input in [Example 3 \(page 70\)](#)

1. Perform steps 1 through 6 of the procedure under [Example 3 \(page 70\)](#).
2. Select [Statistics Calc], and then press OK .



3. Calculate the sum of the sample data (Σx).

$\text{2nd} - [\text{Statistics}] > [\text{Summation}] > [\Sigma x]$

4. Calculate the mean (\bar{x}).

$\text{2nd} - [\text{Statistics}] > [\text{Mean/Var/Dev}\dots] > [\bar{x}]$

Note

- To display the 1-Var Results screen from the statistical calculation screen above, press 2nd and then select [1-Var Results]. To return to the statistical calculation screen from the 1-Var Results screen, press left arrow or AC .

Example 7: To determine the coefficients (a , b) and correlation coefficient (r) of the linear regression equation " $y = a + bx$ " based on the paired-variable data input in [Example 4 \(page 71\)](#)

- Perform steps 1 through 5 of the procedure under [Example 4 \(page 71\)](#).
- Select [Statistics Calc], and then press OK .
 - This displays the regression type menu.

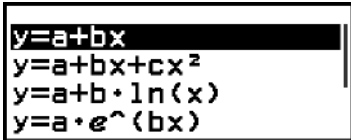

- Select [$y=a+bx$], and then press OK .

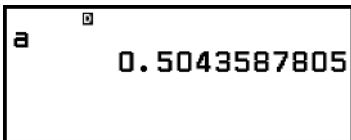

- Determine the coefficients (a , b) and correlation coefficient (r) of the regression equation " $y = a + bx$ ".

$\text{2nd} - [\text{Statistics}] > [\text{Regression}] > [a]$

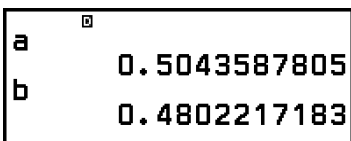
$\text{2nd} - [\text{Statistics}] > [\text{Regression}] > [b]$

☰ – [Statistics] > [Regression] > [*r*]

EXE

b	0.4802217183
r	0.9952824846

- To select a different regression type, press ☰ and then select [Select Reg Type]. This displays the regression type menu from step 2.

To display the 2-Var Results screen from a statistical calculation screen

Press ☰ and then select [2-Var Results].

To display the Reg Results screen from a statistical calculation screen

Press ☰ and then select [Reg Results].

List of Statistical Value Variables and Statistical Calculation Functions

You can use the CATALOG menu to recall variables representing statistical values and functions used for statistical calculations.

Note

- For single-variable statistical calculations, the variables marked with an asterisk (*) are available.
- For the calculation formula used for each variable and command, see "[Statistical Calculation Formula](#)" (page 80).

☰ – [Statistics] > [Summation]

- Σx^* , Σy sum of the sample data
- Σx^{2*} , Σy^2 sum of squares of the sample data
- Σxy sum of products of the *x*-data and *y*-data
- Σx^3 sum of cubes of the *x*-data
- Σx^2y sum of (*x*-data squares × *y*-data)
- Σx^4 sum of biquadrate of the *x*-data

☰ – [Statistics] > [Mean/Var/Dev...]

- \bar{x}^* , \bar{y} mean
- σ_x^2 , σ_y^2 population variance
- σ_x , σ_y population standard deviation
- s_x^2 , s_y^2 sample variance
- s_x , s_y sample standard deviation
- n^* number of items

☰ – [Statistics] > [Min/Max/Quartile] (Single-Variable Data Only)

$\min(x)^*$ minimum value
 Q_1^* first quartile
Med* median
 Q_3^* third quartile
 $\max(x)^*$ maximum value

☞ – **[Statistics] > [Norm Dist]** (Single-Variable Data Only)
 P^* , Q^* , R^* , $\triangleright t^*$ Functions for executing normal distribution calculations. For more information about these functions, see ["Performing Normal Distribution Calculations \(Single-Variable Data Only\)" \(page 78\)](#).

☞ – **[Statistics] > [Min/Max]** (Paired-Variable Data Only)
 $\min(x)$, $\min(y)$ minimum value
 $\max(x)$, $\max(y)$ maximum value

☞ – **[Statistics] > [Regression]** (Paired-Variable Data Only)

For quadratic regression

a , b , c regression coefficients for quadratic regression

\hat{x}_1 , \hat{x}_2 Functions for determining x_1 and x_2 estimated values for an input y -value. For the argument, input the value of y immediately before the \hat{x}_1 or \hat{x}_2 function.

\hat{y} Function for determining the y estimated value for an input x -value. For the argument, input the value of x immediately before this function.

For non-quadratic regression

a , b regression coefficients

r correlation coefficient

\hat{x} Function for determining x estimated value for an input y -value. For the argument, input the value of y immediately before this function.

\hat{y} Function for determining the y estimated value for an input x -value. For the argument, input the value of x immediately before this function.

For an example of the operation to determine estimated values, see ["Calculating Estimated Values \(Paired-Variable Data Only\)" \(page 79\)](#).

Performing Normal Distribution Calculations (Single-Variable Data Only)

While single-variable statistical calculation is selected, you can perform normal distribution calculation using the functions shown below from the

menu that appears when you press 2nd and then select [Statistics] > [Norm Dist].

P(, Q(, R(... These functions take the argument t and determine a probability of standard normal distribution as illustrated below.

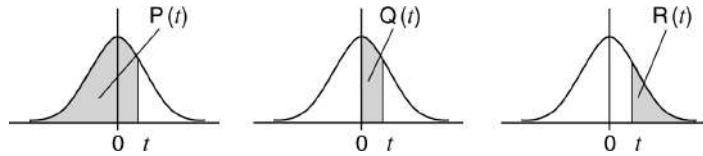

$\blacktriangleright t$ This function is preceded by the argument x . It calculates the standard variate for data value x using the mean value (\bar{x}) and population standard deviation (σ_x) of data input with the Statistics Editor.

$$x \blacktriangleright t = \frac{x - \bar{x}}{\sigma_x}$$

Example 8: For the single-variable data input in [Example 3 \(page 70\)](#), determine the normalized variate when $x = 2$, and $P(t)$ at that point.

1. Perform steps 1 through 6 of the procedure under [Example 3 \(page 70\)](#).
2. Select [Statistics Calc], and then press OK .



3. Calculate the normalized variate when $x = 2$.

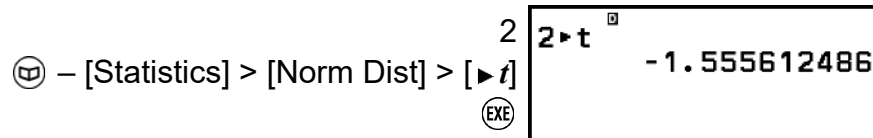

4. Calculate $P(t)$.

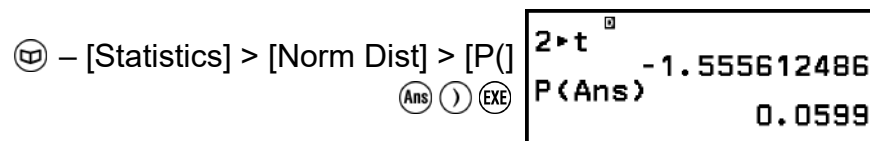

Calculating Estimated Values (Paired-Variable Data Only)

Based on the regression equation obtained by paired-variable statistical calculation, the estimated value of y can be calculated for a given x -value. The corresponding x -value (two values, x_1 and x_2 , in the case of quadratic regression) also can be calculated for a value of y in the regression equation.

Example 9: To determine the estimated value for y when $x = 5.5$ in the regression equation produced by linear regression of the data input in **Example 4 (page 71)**

1. Perform steps 1 through 5 of the procedure under **Example 4 (page 71)**.
2. Select [Statistics Calc], and then press OK .
 - This displays the regression type menu.

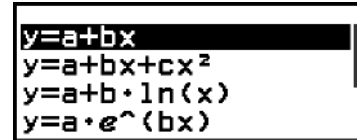

3. Select [$y=a+bx$], and then press OK .

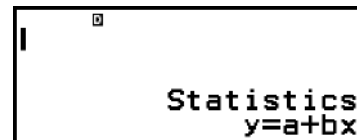

4. Input the x -value (5.5), and then input " \hat{y} ", which is the function to determine the estimated value of y .

OK – [Statistics] > [Regression] > [\hat{y}]



5. Press EXE .

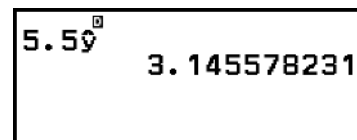

Statistical Calculation Formula

Single-Variable Statistical Calculation Formula

$$\bar{x} = \frac{\sum x}{n}$$

$$\sigma_x = \sqrt{\frac{\sum (x - \bar{x})^2}{n}}$$

$$s_x = \sqrt{\frac{\sum (x - \bar{x})^2}{n - 1}}$$

Paired-Variable Statistical Calculation Formula

$$\bar{x} = \frac{\sum x}{n}$$

$$\sigma_x = \sqrt{\frac{\sum (x - \bar{x})^2}{n}}$$

$$s_x = \sqrt{\frac{\sum (x - \bar{x})^2}{n - 1}}$$

$$\bar{y} = \frac{\sum y}{n}$$

$$\sigma_y = \sqrt{\frac{\sum (y - \bar{y})^2}{n}}$$

$$s_y = \sqrt{\frac{\sum (y - \bar{y})^2}{n - 1}}$$

Regression Calculation Formula

Linear Regression ($y = a + bx$)

$$a = \frac{\sum y - b \cdot \sum x}{n}$$

$$b = \frac{n \cdot \sum xy - \sum x \cdot \sum y}{n \cdot \sum x^2 - (\sum x)^2}$$

$$r = \frac{n \cdot \sum xy - \sum x \cdot \sum y}{\sqrt{\{n \cdot \sum x^2 - (\sum x)^2\} \{n \cdot \sum y^2 - (\sum y)^2\}}}$$

$$\hat{x} = \frac{y - a}{b}$$

$$\hat{y} = a + bx$$

Quadratic Regression ($y = a + bx + cx^2$)

$$a = \frac{\sum y}{n} - b \left(\frac{\sum x}{n} \right) - c \left(\frac{\sum x^2}{n} \right)$$

$$b = \frac{S_{xy} \cdot S_{x^2 x^2} - S_{x^2 y} \cdot S_{xx^2}}{S_{xx} \cdot S_{x^2 x^2} - (S_{xx^2})^2}$$

$$c = \frac{S_{x^2 y} \cdot S_{xx} - S_{xy} \cdot S_{xx^2}}{S_{xx} \cdot S_{x^2 x^2} - (S_{xx^2})^2}$$

$$S_{xx} = \sum x^2 - \frac{(\sum x)^2}{n}$$

$$S_{xy} = \sum xy - \frac{(\sum x \cdot \sum y)}{n}$$

$$S_{xx^2} = \sum x^3 - \frac{(\sum x \cdot \sum x^2)}{n}$$

$$S_{x^2 x^2} = \sum x^4 - \frac{(\sum x^2)^2}{n}$$

$$S_{x^2 y} = \sum x^2 y - \frac{(\sum x^2 \cdot \sum y)}{n}$$

$$\hat{x}_1 = \frac{-b + \sqrt{b^2 - 4c(a - y)}}{2c}$$

$$\hat{x}_2 = \frac{-b - \sqrt{b^2 - 4c(a - y)}}{2c}$$

$$\hat{y} = a + bx + cx^2$$

Logarithmic Regression ($y = a + b \cdot \ln(x)$)

$$a = \frac{\Sigma y - b \cdot \Sigma \ln x}{n}$$

$$b = \frac{n \cdot \Sigma(\ln x)y - \Sigma \ln x \cdot \Sigma y}{n \cdot \Sigma(\ln x)^2 - (\Sigma \ln x)^2}$$

$$r = \frac{n \cdot \Sigma(\ln x)y - \Sigma \ln x \cdot \Sigma y}{\sqrt{\{n \cdot \Sigma(\ln x)^2 - (\Sigma \ln x)^2\} \{n \cdot \Sigma y^2 - (\Sigma y)^2\}}}$$

$$\hat{x} = e^{\frac{y-a}{b}}$$

$$\hat{y} = a + b \ln x$$

e Exponential Regression ($y = a \cdot e^{(bx)}$)

$$a = \exp\left(\frac{\Sigma \ln y - b \cdot \Sigma x}{n}\right)$$

$$b = \frac{n \cdot \Sigma x \ln y - \Sigma x \cdot \Sigma \ln y}{n \cdot \Sigma x^2 - (\Sigma x)^2}$$

$$r = \frac{n \cdot \Sigma x \ln y - \Sigma x \cdot \Sigma \ln y}{\sqrt{\{n \cdot \Sigma x^2 - (\Sigma x)^2\} \{n \cdot \Sigma(\ln y)^2 - (\Sigma \ln y)^2\}}}$$

$$\hat{x} = \frac{\ln y - \ln a}{b}$$

$$\hat{y} = a e^{bx}$$

ab Exponential Regression ($y = a \cdot b^x$)

$$a = \exp\left(\frac{\Sigma \ln y - \ln b \cdot \Sigma x}{n}\right)$$

$$b = \exp\left(\frac{n \cdot \Sigma x \ln y - \Sigma x \cdot \Sigma \ln y}{n \cdot \Sigma x^2 - (\Sigma x)^2}\right)$$

$$r = \frac{n \cdot \Sigma x \ln y - \Sigma x \cdot \Sigma \ln y}{\sqrt{\{n \cdot \Sigma x^2 - (\Sigma x)^2\} \{n \cdot \Sigma(\ln y)^2 - (\Sigma \ln y)^2\}}}$$

$$\hat{x} = \frac{\ln y - \ln a}{\ln b}$$

$$\hat{y} = a b^x$$

Power Regression ($y = a \cdot x^b$)

$$a = \exp\left(\frac{\Sigma \ln y - b \cdot \Sigma \ln x}{n}\right)$$

$$b = \frac{n \cdot \Sigma \ln x \ln y - \Sigma \ln x \cdot \Sigma \ln y}{n \cdot \Sigma(\ln x)^2 - (\Sigma \ln x)^2}$$

$$r = \frac{n \cdot \Sigma \ln x \ln y - \Sigma \ln x \cdot \Sigma \ln y}{\sqrt{\{n \cdot \Sigma(\ln x)^2 - (\Sigma \ln x)^2\} \{n \cdot \Sigma(\ln y)^2 - (\Sigma \ln y)^2\}}}$$

$$\hat{x} = e^{\frac{\ln y - \ln a}{b}}$$

$$\hat{y} = a x^b$$

Inverse Regression ($y = a + b/x$)

$$a = \frac{\Sigma y - b \cdot \Sigma x^{-1}}{n}$$

$$b = \frac{S_{xy}}{S_{xx}}$$

$$r = \frac{S_{xy}}{\sqrt{S_{xx} \cdot S_{yy}}}$$

$$S_{xx} = \Sigma(x^{-1})^2 - \frac{(\Sigma x^{-1})^2}{n}$$

$$S_{yy} = \Sigma y^2 - \frac{(\Sigma y)^2}{n}$$

$$S_{xy} = \Sigma(x^{-1})y - \frac{\Sigma x^{-1} \cdot \Sigma y}{n}$$

$$\hat{x} = \frac{b}{y - a}$$

$$\hat{y} = a + \frac{b}{x}$$

Distribution Calculations

In the Distribution app, you can obtain the probability value by selecting the distribution calculation type and inputting various parameters.*

Executable distribution calculation types are shown in the table below.

Distribution Calculation Type	Menu Item
Binomial probability	Binomial PD
Binomial cumulative probability	Binomial CD
Normal probability density	Normal PD
Normal cumulative probability	Normal CD
Inverse normal cumulative distribution*	Inverse Normal
Poisson probability	Poisson PD
Poisson cumulative probability	Poisson CD

* "Inverse Normal" performs inverse calculation to determine the data value (x_{Inv}) from a probability value (Area).

General Procedure for Performing a Distribution Calculation

Example: To calculate binomial cumulative probability for the x data {2, 3, 4, 5} when N (number of trials) = 5 and p (probability of success) = 0.5

1. Press Δ , select the Distribution app icon, and then press OK .
 - This displays the distribution calculation type menu.

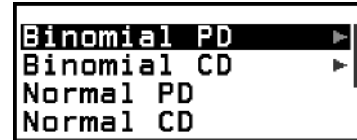

2. On the menu, select a distribution calculation type.
 - Here we want to calculate binomial cumulative probability. Select [Binomial CD], and then press OK .
3. On the menu that appears, select a data (x) input method.

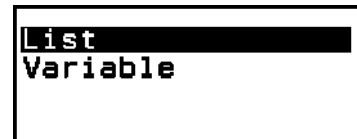

[List] ... Select to input multiple x -data items at the same time. Selecting this menu item causes the list screen to appear.

[Variable] ... Select to input a single x -data item. Selecting this menu item causes a parameter input screen to appear.

- Here we want to input multiple x -data items at the same time, select [List] and then press OK .

4. On the list screen, input x data {2, 3, 4, 5}.

2 EXE 3 EXE 4 EXE 5 EXE

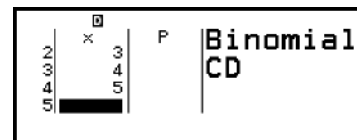

5. Press OK .
 - This displays the Binomial CD parameter input screen.
6. Input values for the parameters ($N = 5$, $p = 0.5$).

5 EXE 0 EXE . EXE 5 EXE

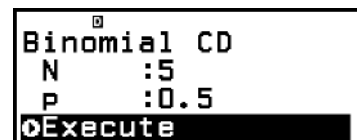

- The parameters that require data input depend on the calculation type you selected in step 2 of this procedure. For details, see the ["Parameter List" \(page 85\)](#).

7. After inputting values for all of the variables, select [Execute] and then press OK .

- This displays the calculation result screen.

	x	P	Binomial CD
1	2	0.5	
2	3	0.8125	
3	4	0.9687	
4	5	1	

- If you selected [List] in step 3, calculation results (P column) will appear on the list screen. For details, see ["List Screen" \(page 86\)](#).
- If you perform any editing operation (see ["Editing the List Screen Contents" \(page 87\)](#)) on the list screen while calculation results are displayed, all the calculation results will be cleared. The list will return to its state in step 4 (list screen data input complete) of this procedure.
- An error message appears if the input value is outside the allowable range. "ERROR" will appear in the P column of the calculation result screen when the value input for the corresponding data is outside the allowable range.
- Pressing OK while the calculation result screen is displayed will return to the parameter input screen.

Note

- If you selected Normal PD, Normal CD, or Inverse Normal in step 2 above, the data (x) input method is always "Variable" (single x -data item input). Because of this, the menu in step 3 is not displayed at this time.
- If the data (x) input method is "Variable", the calculation result will be stored in Ans memory.
- Distribution calculation accuracy is up to 6 significant digits.

Parameter List

The list below shows the meanings of the symbols that appear on the parameter input screen.

Binomial PD, Binomial CD

x ... data

N ... number of trials

p ... probability of success ($0 \leq p \leq 1$)

Normal PD

x ... data

μ ... population mean

σ ... population standard deviation ($\sigma > 0$)

Normal CD

Lower ... lower boundary

Upper ... upper boundary

μ ... population mean
 σ ... population standard deviation ($\sigma > 0$)

Inverse Normal

Area ... probability value ($0 \leq \text{Area} \leq 1$)
 μ ... population mean
 σ ... population standard deviation ($\sigma > 0$)
 (Tail setting always left.)

Poisson PD, Poisson CD

x ... data
 λ ... mean

Note

- The last value input for each parameter name is retained, regardless of the input screen where it is input. For example, inputting a value for N on the Binomial PD parameter input screen will also change the value of N on the Binomial CD parameter input screen.
- The values you input for each of the parameters are retained as long as you do not execute either of the following operations: ⊞ – [Reset] > [Settings & Data] or ⊞ – [Reset] > [Initialize All].

List Screen

You can use the list screen to input up to 45 x -data items. Calculation results are also displayed on the list screen.

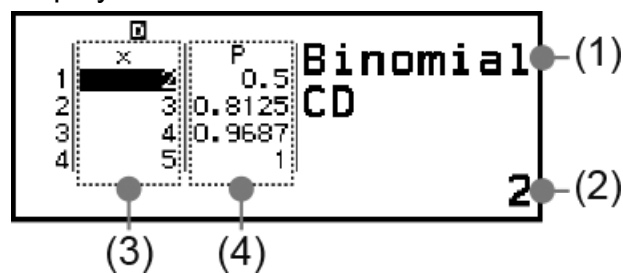

- (1) Distribution calculation type
- (2) Value at current cursor position
- (3) Data (x)
- (4) Calculation results (P)

Note

- On the list screen, you can store the value in a cell to a variable. For example, performing the following operation while the above screen is displayed will store 1 to variable A: ⊞ – [A=] > [Store]. For details about variables, see "[Variables \(A, B, C, D, E, F, x, y, z\)](#)" (page 36).
- Performing one of the operations below deletes all x -data input on the list screen.
 - Returning to the HOME screen and launching another calculator app

- Executing [Delete All] (See ["To delete all list screen contents" \(page 87\).](#))
- Executing ☰ – [Reset] > [Settings & Data] or ☰ – [Reset] > [Initialize All]

Editing the List Screen Contents

To change the x data in a cell

On the list screen, move the cursor to the cell containing the data you want to change, input the new data, and then press EXE .

To delete a row

On the list screen, move the cursor to the row you want to delete and then press ✕ .

To insert a row

1. On the list screen, move the cursor to the row that will be under the row you will insert.
2. Perform the following operation: ☉ – [Edit] > [Insert Row].
 - This inserts a row with 0 input as the initial default value.

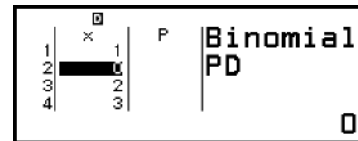

3. Input the data.

To delete all list screen contents

On the list screen, perform the following operation: ☉ – [Edit] > [Delete All].

Calculation Example

To calculate the normal probability density when $x = 36$, $\mu = 35$, $\sigma = 2$

1. Press ☰ , select the Distribution app icon, and then press OK .
2. On the distribution calculation type menu that appears, select [Normal PD], and then press OK .
 - This displays the Normal PD parameter input screen.
3. Input values for the parameters ($x = 36$, $\mu = 35$, $\sigma = 2$).

36 EXE 35 EXE 2 EXE

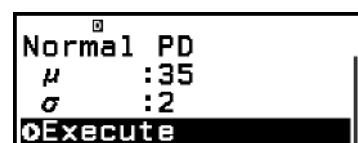

4. Press OK .

P= 0.1760326634

- Pressing **OK** again or pressing **↶** or **AC** returns to the parameter input screen in step 3 of this procedure.
- You can store the currently displayed calculation result to a variable. For example, performing the following operation while the screen in step 4 is displayed above will store the calculation result to variable A: **↶** – [A=] > [Store]. For details about variables, see "**Variables (A, B, C, D, E, F, x, y, z)**" (page 36).

Using Spreadsheet

The Spreadsheet app makes it possible to perform calculations using a 45-row × 5-column (cell A1 to E45) spreadsheet.

To perform the operations in this section, first launch the Spreadsheet app. Press **⏏**, select the Spreadsheet app icon, and then press **OK**. This displays the spreadsheet screen.

	A	B	C	D
1	170	179	176	176
2	173	175	171	182
3	177	175	175	177
4	520			

=Sum(A1:A3)

- (1) Row numbers (1 to 45)
- (2) Column letters (A to E)
- (3) Cursor: Indicates the currently selected cell. The row number and column letter of the currently selected cell are displayed in black, and the other cell row numbers and column letters are displayed in dark gray.
- (4) Edit box: Shows the contents of the cell where the cursor is currently located.

Important!

- Any time you turn off the calculator or press the **⏏** key, every input into the spreadsheet is cleared.

Inputting and Editing Cell Contents

You can input a constant or a formula into each cell.

Constants: A constant is something whose value is fixed as soon as you finalize its input. A constant can be either a numeric value, or a calculation

expression (such as $7+3$, $\sin 30$, $A1 \times 2$, etc.) that does not have an equal sign (=) in front of it.

Formulas: A formula that starts with an equal sign (=), such as $=A1 \times 2$, is executed as it is written.

Note

- A maximum of 49 bytes can be input into a cell (number of bytes before the input is confirmed by pressing EXE) that is being edited. How the number of bytes is counted is shown below.
 - Numerals, variables, symbols: 1 byte per character
 - Commands, functions: 1 byte each

Each entire command or function is counted as one byte. For example, the following are one byte: " $\sqrt{\quad}$ ", "Sum(".
- The number of bytes consumed after the input is confirmed is as shown below, according to the contents entered in each cell.
 - Constants: 14 bytes, regardless of the number of input digits*
 - Formulas: Number of input bytes (49 bytes maximum) + 15 bytes

* If you enter a constant with 11 or more significant digits, the value will be converted to 10 significant digits when the input is confirmed.

Example: If you input 12345678915 (11 digits), the value will be converted to $1.234567892 \times 10^{10}$ (10 digits).

To display the remaining input capacity

Press MEM , select [Available Memory], and then press OK .

Inputting a Constant and Formula into a Cell

Example 1: Into cells A1, A2, and A3, input constants 7×5 , 7×6 , and $A2+7$ respectively. And then, input the following formula into cell B1: $=A1+7$.

1. Move the cursor to cell A1.
2. Perform the key operation below.

$7 \times 5 \text{ EXE } 7 \times 6 \text{ EXE } \uparrow 4 (A) 2 + 7 \text{ EXE}$

	A	B	C	D
1	35			
2	42			
3	49			
4				

3. Move the cursor to cell B1, and then perform the key operation below.

$\uparrow \leftarrow (=) \uparrow 4 (A) 1 + 7 \text{ EXE}$

	A	B	C	D
1	35	42		
2	42			
3	49			
4				

Note

- On the spreadsheet screen, you can store the value in a cell to a variable. For example, performing the following operation while the screen in step 3 is displayed will

store 42 (calculation result of the formula input into cell B1) to variable A: \wedge [Store] – [A=] > [Store]. For details about variables, see "[Variables \(A, B, C, D, E, F, x, y, z\)](#)" (page 36).

- You can specify whether a formula in the edit box should be displayed as it is or as its calculation result value. See "[Spreadsheet App Setting Items](#)" (page 94).

To edit existing cell data

1. Move the cursor to the cell whose contents you want to edit, and then press [OK] .
 - Instead of pressing [OK] , you can also perform the operation below.
 - [Edit Cell] – [Edit Cell]
 - Cell contents in the edit box will change from align right to align left. A text cursor (|) will appear in the edit box so you can edit its contents.
2. Use [Left] and [Right] to move the text cursor around the contents of the cell, and edit them as required.
3. To finalize and apply your edits, press [EXE] .

To input a cell reference name using the Grab command

The Grab command can be used in place of manual reference name (such as A1) input using a key operation to select and input a cell you want to reference.

Example 2: Continuing from Example 1, input the following formula into cell B2: =A2+7.

1. Move the cursor to cell B2.
2. Perform the operation below.

$\text{[Up]} \text{[Left]} (=) \text{[Grab]} - [\text{Spreadsheet}] > [\text{Grab}]$

$\text{[OK]} \text{[+] 7 \text{[EXE]}$

	A	B	C	D
1	35	42		
2	42			
3	49			
4				

Set : [OK]

	A	B	C	D
1	35	42		
2	42	49		
3	49			
4				

Cell Relative and Absolute References

There are two types of cell reference: relative and absolute.

Relative cell reference

The cell reference (A1) in a formula like =A1+7 is a relative reference, which means that it changes depending on the cell where the formula is located. If the formula =A1+7 is originally located in cell B1, for example,

copying and then pasting to cell C3 will result in =B3+7 being input into cell C3. Since the copy and paste operation moves the formula one column (B to C) and two rows (1 to 3) the A1 relative cell reference in the formula is moved one column and two rows to B3. If the result of a copy and paste operation causes a relative cell reference name to change to something that is outside the range of the spreadsheet cells, the applicable column letter and/or row number will be replaced by a question mark (?), and "ERROR" will be displayed as the cell's data.

Absolute cell reference

If you want the row or the column, or both the row and the column parts of a cell reference name to remain the same no matter where you paste them, you need to create an absolute cell reference name. To create an absolute cell reference, put a dollar sign (\$) in front of the column name and/or row number. You can use one of three different absolute cell references: absolute column with relative row (\$A1), relative column with absolute row (A\$1), or absolute row and column (\$A\$1).

To input the absolute cell reference symbol (\$)

While inputting a formula into a cell, press Ⓜ and then select [Spreadsheet] > [\$].

To cut and paste spreadsheet data

1. Move the cursor to the cell whose data you want to cut.
2. Press Ⓞ , select [Cut & Paste], and then press Ⓚ .
 - This enters paste standby. To cancel paste standby, press Ⓢ or Ⓐ .
3. Move the cursor to the cell into which you want to paste the data you just cut, and then press Ⓚ .
 - Pasting data simultaneously deletes the data from the cell where you performed the cut operation, and automatically cancels paste standby.

Note

- In the case of a cut and paste operation, cell references do not change when pasted, regardless of whether they are relative or absolute.

To copy and paste spreadsheet data

1. Move the cursor to the cell whose data you want to copy.
2. Press Ⓞ , select [Copy & Paste], and then press Ⓚ .
 - This enters paste standby. To cancel paste standby, press Ⓢ or Ⓐ .

3. Move the cursor to the cell into which you want to paste the data you just copied, and then press **OK**.
 - Paste standby remains enabled until you press **⏪** or **AC**, so you can paste the copied data to other cells, if you want.

Note

- When you copy the contents of a cell containing a formula with a relative reference, the relative reference will change in accordance with the location of the cell where the contents are pasted.

To delete input data from a specific cell

Move the cursor to the cell whose contents you want to delete and then press **X**.

To delete the contents of all the cells in a spreadsheet

Press **⋮**, select [Delete All], and then press **OK**.

Using Spreadsheet App Special Commands

In the Spreadsheet app, the commands below can be used inside formulas or constants. These commands are on the menu that appears when you press **⊕** and then select [Spreadsheet].

Min(

Returns the minimum of the values in a specified range of cells.

Syntax: Min(start cell:end cell)

Max(

Returns the maximum of the values in a specified range of cells.

Syntax: Max(start cell:end cell)

Mean(

Returns the mean of the values in a specified range of cells.

Syntax: Mean(start cell:end cell)

Sum(

Returns the sum of the values in a specified range of cells.

Syntax: Sum(start cell:end cell)

Example 3: Continuing from Example 1, input the formula =Sum(A1:A3), which calculates the sum of cells A1, A2, and A3, into cell A4.

1. Move the cursor to cell A4.
2. Input =Sum(A1:A3).

↑ ((=) ☒ – [Spreadsheet] > [Sum]
 ↑ ④ (A) ①
 ☒ – [Spreadsheet] > [:]
 ↑ ④ (A) ③)

	A	B	C	D
1	35	42		
2	42			
3	49			
4				

=Sum(A1:A3)

3. Press **EXE**.

	A	B	C	D
2	42			
3	49			
4	126			
5				

Batch Inputting the Same Formula or Constant into Multiple Cells

You can use the procedures in this section to input the same formula or constant into a specific series of cells. Use the Fill Formula command to batch input a formula, or Fill Value to batch input a constant.

Note

- If the input formula or constant includes a relative reference, the relative reference will be input in accordance with the upper-left cell of the specified range. If the input formula or constant includes an absolute reference, the absolute reference will be input into all of the cells in the specified range.

To batch input the same formula into a series of cells

Example 4: Continuing from Example 1, batch input into cells B1, B2, and B3 a formula that doubles the value of the cell to the left and then subtracts 3.

1. Move the cursor to cell B1.
2. Press **☐**, select [Fill Formula], and then press **OK**.
 - This displays a Fill Formula screen.
3. In the "Form" line, input the formula =2A1-3: 2 ↑ ④ (A) ① – 3 **EXE**.
 - Input of the equals symbol (=) at the beginning is not required.
4. In the "Range" line, specify B1:B3 as the range of the batch input.

OK ✓ ✕ ③ EXE

Fill Formula
Form =2A1-3
Range :B1:B3
Confirm

5. To apply the input, press **OK**.
 - This inputs =2A1-3 into cell B1, =2A2-3 into cell B2, and =2A3-3 into cell B3.

	A	B	C	D
1	35	67		
2	42	81		
3	49	95		
4				=2A1-3

To batch input the same constant into a series of cells

Example 5: Continuing from Example 4, batch input into cells C1, C2, and C3 values that are triple the values in the cells to their left.

1. Move the cursor to cell C1.
2. Press F10 , select [Fill Value], and then press OK .
 - This displays a Fill Value screen.
3. In the "Value" line, input the constant $B1 \times 3$: F5 (B) F1 F3 EXE .
4. In the "Range" line, specify C1:C3 as the range of the batch input.



5. To apply the input, press OK .
 - This inputs the values of each calculation result into cells C1, C2, and C3.

	A	B	C	D
1	35	67	201	
2	42	81	243	
3	49	95	285	
4				201

Spreadsheet App Setting Items

The setting items below are included on the TOOLS menu.

" \blacklozenge " indicates the initial default setting.

Auto Calc

Specifies whether or not formulas should be re-calculated automatically.

On \blacklozenge : Enables auto re-calculation.

Off: Disables auto re-calculation.

Show Cell

Specifies whether a formula in the edit box should be displayed as it is or as its calculation result value.

Formula \blacklozenge : Displays the formula as it is.

Value: Displays the calculation result value of the formula.

Auto Calc and Recalculate

"Auto Calc" is a setting item on the TOOLS menu (see "[Spreadsheet App Setting Items](#)" (page 94)).

With the Spreadsheet app's initial default setting (Auto Calc: On), formulas in a cell are automatically re-calculated each time the cell contents are edited. Depending on the content of the spreadsheet, auto re-calculation can take a long time to complete. When Auto Calc is disabled (Off), you need to execute re-calculation manually as required.

To execute re-calculation manually

Press \odot , select [Recalculate], and then press OK .

Note

- Even if the Auto Calc setting is On, you should execute [Recalculate] in the cases below.
 - When the SETTINGS menu is used to change the Angle Unit setting
 - When a cell contains a formula using the function "f(" or "g(" and the corresponding defining equation ($f(x)$ or $g(x)$) is updated
 - When a cell contains a formula using a variable and the corresponding variable is updated

Creating a Number Table

You can use the Table app to create a number table based on the defining equations registered for functions $f(x)$ and $g(x)$.

General Procedure for Creating a Number Table

Example : To generate a number table for the functions $f(x) = x^2 + \frac{1}{2}$ and $g(x) = x^2 - \frac{1}{2}$ for the range $-1 \leq x \leq 1$, incremented in steps of 0.5

1. Press \odot , select the Table app icon, and then press OK .
 - This displays the number table screen.
 - If a defining equation is not registered for either or both of $f(x)$ and $g(x)$ and the data at the cursor selection position is empty, a message will appear at the bottom of the screen indicating that the defining equation is not registered.

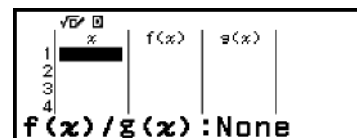

2. Configure settings to generate a number table from two functions.

(1) Press \odot , and then select [Table Type] > [f(x)/g(x)].

(2) Press AC .

- For information about settings, see **"Maximum Number of Rows in a Number Table According to Table Type"** (page 96).

3. Register a defining equation for $f(x)$.

$$\odot - [\text{Define } f(x)/g(x)] > [\text{Define } f(x)] \quad \boxed{f(x) = x^2 + \frac{1}{2}}$$

(Screen immediately before you pressed EXE)

4. Register a defining equation for $g(x)$.

$$\odot - [\text{Define } f(x)/g(x)] > [\text{Define } g(x)] \quad \boxed{g(x) = x^2 - \frac{1}{2}}$$

(Screen immediately before you pressed EXE)

- You can also use f(x) to register a defining expression. For more information, see **"Defining Equation Registration"** (page 97).

5. Configure the number table range setting.

$$\uparrow \odot - [\text{Table Range}] \quad \boxed{\begin{array}{l} \sqrt{\text{EX}} \square \\ \text{Table Range} \\ \text{End} : 1 \\ \text{Step} : 0.5 \\ \text{Execute} \end{array}}$$

6. Press EXE .

- This displays the result in the number table screen.

x	$f(x)$	$g(x)$
1	1.5	0.5
2	0.75	-0.25
3	0	-0.5
4	0.75	-0.25

- 1

- The number table generation operation causes the contents of variable x to be changed.

Note

- On the number table screen, you can store the value in a cell to a variable. For example, performing the following operation while the screen in step 6 is displayed above will store -1 to variable A: $\text{ALPHA} \text{A} = \text{Cell} > [\text{Store}]$. For details about variables, see **"Variables (A, B, C, D, E, F, x, y, z)"** (page 36).

Maximum Number of Rows in a Number Table According to Table Type

You can configure number table screen settings to show columns for both $f(x)$ and $g(x)$, or for either one of them. To set it, use the menu that

appears when you press \odot – [Table Type] while the number table screen is displayed.

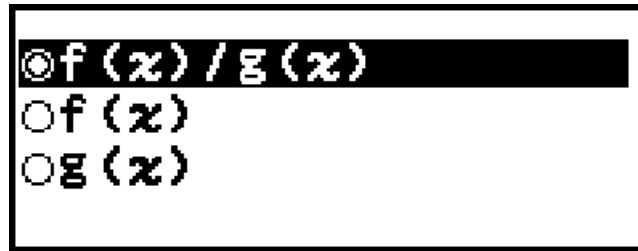

$f(x)/g(x)$... Show both $f(x)$ - and $g(x)$ -columns (initial default setting)

$f(x)$... Show only $f(x)$ -column

$g(x)$... Show only $g(x)$ -column

The maximum number of rows in the generated number table depends on the Table Type setting. Up to 45 rows are supported for the " $f(x)$ " or " $g(x)$ " setting, while 30 rows are supported for the " $f(x)/g(x)$ " setting.

Defining Equation Registration

There are two ways to register defining equations for $f(x)$ and $g(x)$.

- While the Table app number table screen is displayed, registering an equation by pressing \odot
 - \odot – [Define $f(x)/g(x)$] > [Define $f(x)$]
 - \odot – [Define $f(x)/g(x)$] > [Define $g(x)$]
- While the Table app number table screen is displayed, or while using any calculator app except Distribution, Equation (Simul Equation / Polynomial), Inequality, Base-N, Ratio and Math Box, registering an equation by pressing \odot
 - \odot – [Define $f(x)$]
 - \odot – [Define $g(x)$]

The same $f(x)$ or $g(x)$ equation registration screen appears regardless of which of the two above operations is used to register defining equations.

Note

- For details about operations using \odot , see "[Registering and Using Defining Equations for \$f\(x\)\$ and \$g\(x\)\$](#) " (page 61).

Editing Number Table Screen Data

To delete a row

1. On the number table screen, move the cursor to the row you want to delete.
2. Press \odot .

To insert a row

1. On the number table screen, move the cursor to the row that will be under the row you will insert.
2. Perform the following operation: $\odot\odot\odot$ – [Edit] > [Insert Row].

To delete all number table screen contents

On the number table screen, perform the following operation: $\odot\odot\odot$ – [Edit] > [Delete All].

To change the value input in a cell in column x

You can change the value in the currently highlighted x cell. Changing the x value causes the $f(x)$ and $g(x)$ values in the same row to be updated accordingly.

To enter a value into the highlighted x -column cell using: {value of the cell above} +/- {step value}

If there is value in the x cell above the currently highlighted x cell, pressing \oplus or $\textcircled{\text{EXE}}$ automatically inputs into the highlighted cell the value equal to the value of the cell above it plus the step value. So also, pressing \ominus automatically inputs the value equal to the value of the cell above less the step value. The $f(x)$ and $g(x)$ values in the same row are also updated accordingly.

$f(x)$ and $g(x)$ Update Timing

$f(x)$ and $g(x)$ values displayed on the number table screen are updated when any of the following occurs.

- When $\textcircled{\text{EXE}}$ is pressed while [Execute] is selected on the Table Range screen.
- When the defining equations for $f(x)$ and $g(x)$ are updated (except when a defining equation is a composite function).
- When a number is input into column x (including pressing \oplus , \ominus , $\textcircled{\text{EXE}}$ in column x).

Note, however, that values are not updated automatically after the following operations.

- When the SETTINGS menu is used to change the Angle Unit setting.
- When the variable of a defining equation is updated (new numeric value stored) when a defining equation that contains a variable (example: $f(x) = 2x + A$) is registered.

- When the defining equation of a composite function (Example: $g(x) = f(x) \times 2 - x$) is registered, and the defining equation of the reference function (Example: $f(x)$ of $g(x) = f(x) \times 2 - x$) is updated (new defining equation registered).

In these cases, execute ⓪ – [Recalculate] while the number table screen is displayed to update values.

Data Retention

Doing the following will discard some data and clear some settings of the Table app.

- ① Returning to the HOME screen and launching another calculator app.
- ② Pressing ⏏ .
- ③ Changing the Input/Output setting with the SETTINGS menu.
- ④ Changing the Table Type setting with the TOOLS menu.

The table below shows which data is discarded and which data is retained.

Operation Data, Setting	①	②	③	④
Number table data (x -, $f(x)$ -, $g(x)$ -columns)	Discarded	Discarded	Discarded	Discarded
Table Range settings	Discarded	Retained	Retained	Retained
Table Type settings	Retained	Retained	Retained	--
$f(x)$, $g(x)$ defining equations	Retained	Discarded	Discarded	Retained

Equation Calculations

The Equation app includes the three functions described below. After starting up the app, you can use the Equation menu that appears to select the function you want.

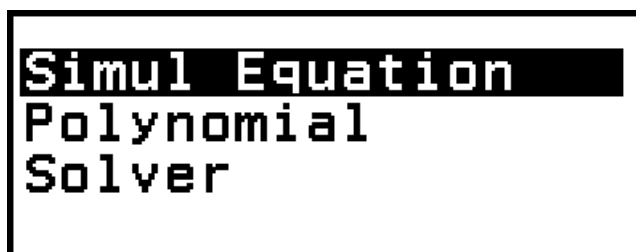

Simul Equation: Simultaneous linear equations with two to four unknowns

Polynomial: High-order equations from 2nd to 4th degree

Solver: Function to find the value of any variable contained in an input equation

Simultaneous Linear Equations

Here, we explain the general procedure for solving a simultaneous equation with an example that solves a simultaneous linear equation with three unknowns.

Example 1:
$$\begin{cases} x - y + z = 2 \\ x + y - z = 0 \\ -x + y + z = 4 \end{cases}$$

- Press \odot , select the Equation app icon, and then press OK .
 - This displays the Equation menu.

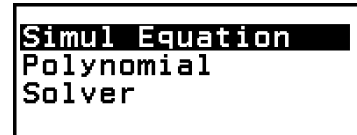

- Select [Simul Equation], and then press OK .
 - This displays the number of unknowns menu.



- Select [3 Unknowns], and then press OK .
 - This displays the Coefficient Editor.

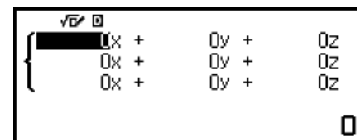

- Use the Coefficient Editor to input coefficient values.

$1 \text{ (EXE)} \uparrow \ominus ((-)) 1 \text{ (EXE)} 1 \text{ (EXE)} 2 \text{ (EXE)}$
 $1 \text{ (EXE)} 1 \text{ (EXE)} \uparrow \ominus ((-)) 1 \text{ (EXE)} 0 \text{ (EXE)}$
 $\uparrow \ominus ((-)) 1 \text{ (EXE)} 1 \text{ (EXE)} 1 \text{ (EXE)} 4 \text{ (EXE)}$

- Pressing AC while the Coefficient Editor is displayed will clear all of the coefficients to zero.
- Press EXE .
 - This will display a solution.



- While the \blacktriangledown indicator is displayed, each press of \checkmark (or EXE) will display another solution.

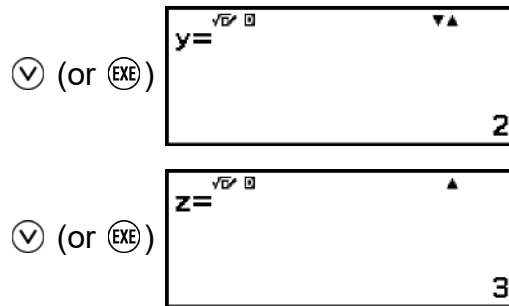

- Pressing \wedge or \ominus while the \blacktriangle indicator is displayed causes the previously displayed solution to reappear.
- Pressing EXE while the final solution is displayed returns to the Coefficient Editor. To return to the Coefficient Editor while any solution is displayed, press AC .
- Pressing \ominus while the Coefficient Editor is displayed returns to the number of unknowns menu.

Note

- While the Coefficient Editor is displayed, you can store the currently highlighted value to a variable. Also, while the solution is being displayed, the currently displayed solution can be stored to a variable. For details about variables, see "[Variables \(A, B, C, D, E, F, x, y, z\)](#)" (page 36).

High-order Equations from 2nd to 4th Degree

When you solve a high-order equation with the Equation app, the values below are displayed according to the degree of the equation.

• Quadratic Equation

Following the display of the solution of $ax^2+bx+c=0$, the minimum (or maximum) coordinates (x, y) for $y=ax^2+bx+c$ are displayed.

• Cubic Equation

Following the display of the solution of $ax^3+bx^2+cx+d=0$, the coordinates (x, y) of the local minimum (or local maximum) of $y=ax^3+bx^2+cx+d$ are displayed, only if a local minimum or local maximum exists. If a local minimum or local maximum does not exist, pressing EXE while the last solution is displayed will cause the message "No Local Max/Min" to appear.

• Quartic Equation

The solution of $ax^4+bx^3+cx^2+dx+e=0$ is displayed.

Here we will show an example of a quadratic equation to explain the general procedure for solving a high-order equation.

Example 2: $x^2 + 2x - 2 = 0$

(Input/Output: MathI/MathO)

1. Press \odot , select the Equation app icon, and then press OK .

- This displays the Equation menu.

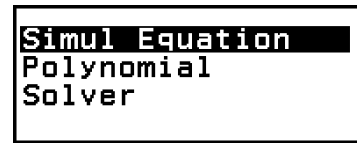

2. Select [Polynomial], and then press OK .

- This displays the number of degrees menu.

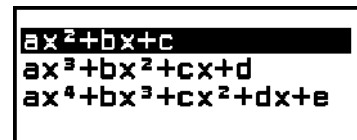

3. Select [ax^2+bx+c], and then press OK .

- This displays the Coefficient Editor.

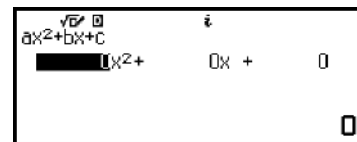

4. Use the Coefficient Editor to input coefficient values.

$1 \text{ EXE } 2 \text{ EXE } \uparrow \ominus ((-)) 2 \text{ EXE}$

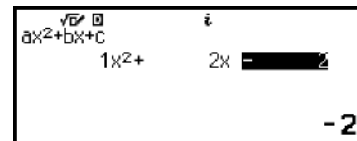

- Pressing AC while the Coefficient Editor is displayed will clear all of the coefficients to zero.

5. Press EXE .

- This will display a solution.

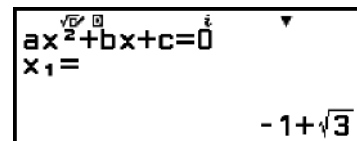

- While the \blacktriangledown indicator is displayed, each press of V (or EXE) will display another calculation result (solution or coordinate).

V (or EXE)

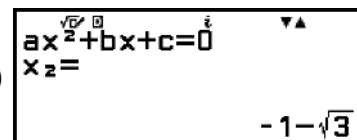

(Displays x -coordinate of minimum of $y = x^2 + 2x - 2$.)

\odot (or EXE)

$\sqrt{\square}$ \square Min of $y=ax^2+bx+c$ $x=$ -1
--

(Displays y -coordinate of minimum of $y = x^2 + 2x - 2$.)

\odot (or EXE)

$\sqrt{\square}$ \square Min of $y=ax^2+bx+c$ $y=$ -3
--

- Pressing \uparrow or \rightarrow while the \blacktriangle indicator is displayed causes the previously displayed calculation result to appear again.
- Pressing EXE while the final calculation result is displayed returns to the Coefficient Editor. To return to the Coefficient Editor while any calculation result is displayed, press AC .
- Pressing \rightarrow while the Coefficient Editor is displayed returns to the number of degrees menu.

Note

- While the Coefficient Editor is displayed, you can store the currently highlighted value to a variable. Also, while a calculation result (solution or coordinate) is displayed, it can be stored to a variable. For details about variables, see "[Variables \(A, B, C, D, E, F, x, y, z\)](#)" (page 36).

Complex Number Solution Display (Complex Roots)

High-order equations may have complex number solutions. When Polynomial is selected on the Equation menu, you can use the operations below to enable or disable complex number solution display.

$\odot\odot\odot$ – [Complex Roots] > [On] AC

Enables complex number solution display (initial default setting).

$\odot\odot\odot$ – [Complex Roots] > [Off] AC

Disables complex number solution display. Inputting and executing an equation that has one or more complex number solutions only will cause the message "No Real Roots" to appear.

Example 3: $2x^2 + 3x + 4 = 0$

(Input/Output: MathI/MathO, Complex Result: $a+bi$, Complex Roots: On)

1. Press \odot , select the Equation app icon, and then press OK .

- This displays the Equation menu.

Simul Equation
Polynomial
Solver

2. Select [Polynomial] > [ax^2+bx+c].
- This displays the Coefficient Editor.

ax^2+bx+c
 $1x^2+ 0x + 0$

3. Use the Coefficient Editor to input coefficient values.

2 [EXE] 3 [EXE] 4 [EXE]
 ax^2+bx+c
 $2x^2+ 3x + 4$

4. Press [EXE].
- This will display a solution.

$ax^2+bx+c=0$
 $x_1 = \frac{-3+\sqrt{23}i}{4}$

5. Display another solution and coordinate values.

[V] (or [EXE])
 $ax^2+bx+c=0$
 $x_2 = \frac{-3-\sqrt{23}i}{4}$

[V] (or [EXE])
 Min of $y=ax^2+bx+c$
 $x = -\frac{3}{4}$

[V] (or [EXE])
 Min of $y=ax^2+bx+c$
 $y = \frac{23}{8}$

- Pressing [EXE] while the final calculation result is displayed returns to the Coefficient Editor. To return to the Coefficient Editor while any calculation result is displayed, press [AC].

Converting a Complex Number Solution to Rectangular or Polar Coordinates

You can use the FORMAT menu that appears when you press FORMAT to convert a complex number solution to rectangular coordinate or polar coordinate format.

Example 4: To convert the complex number solution displayed in **Example 3 (page 103)** to polar coordinate format and then to rectangular coordinate format

1. Perform steps 1 to 4 of **Example 3 (page 103)**.

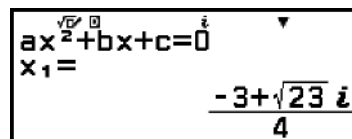

Calculator screen showing the equation $ax^2+bx+c=0$ and the solution $x_1 = \frac{-3+\sqrt{23}i}{4}$.

2. Press FORMAT , select [Polar Coord], and then press OK .

- This converts the solution to polar coordinate format.

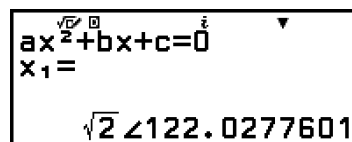

Calculator screen showing the equation $ax^2+bx+c=0$ and the solution $x_1 = \sqrt{2} \angle 122.0277601$.

3. Press FORMAT , select [Rectangular Coord], and then press OK .

- This converts the solution to rectangular coordinate format.

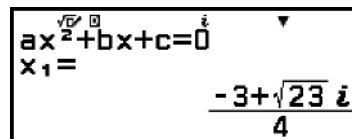

Calculator screen showing the equation $ax^2+bx+c=0$ and the solution $x_1 = \frac{-3+\sqrt{23}i}{4}$.

Using Solver

Solver uses Newton's method to approximate the solution of equations.

Solver supports input of equations of the following formats.

Examples: $y = x + 5$, $x = \sin(A)$, $xy + C$ (Treated as $xy + C = 0$)

Example 5: To solve $x^2 - \frac{B}{2} = 0$ for x when $B = 4$

(Input/Output: MathI/MathO)

Note

- Before solving $x^2 - \frac{B}{2} = 0$ for x , 4 needs to be stored to variable B. This is done in step 3 of the procedure below.

1. Press MODE , select the Equation app icon, and then press OK .

- This displays the Equation menu.

2. Select [Solver], and then press OK .

- This displays the Solver equation input screen.
3. Here, store 4 to variable B.

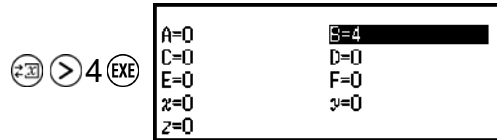

- This operation can be executed at any point before step 7 of this procedure.
 - For details about variables, see "[Variables \(A, B, C, D, E, F, x, y, z\)](#)" ([page 36](#)).
 - Press (←) to return to the Solver equation input screen.
4. Input the equation.

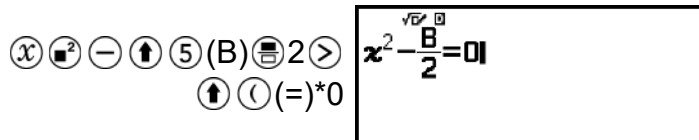

* You can also use the following operation to input = sign: (⊖) – [Equation] > [=].

5. Press (EXE) to register the input equation.
6. On the Solve Target screen that appears, confirm that [x] is selected and then press (OK).
- This displays a screen with the initial value of x .

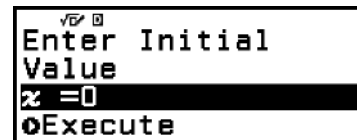

7. Input 1 as the initial value of x .



8. After making sure that [Execute] is selected, press (EXE) to solve the equation.

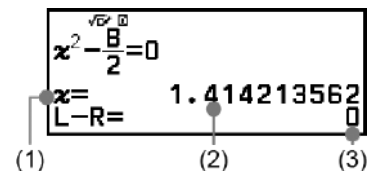

- (1) Variable solved for
- (2) Solution
- (3) (Left Side) – (Right Side) result

- Solutions are always displayed in decimal form.

- The closer the (Left Side) – (Right Side) result is to zero, the higher the accuracy of the solution.

9. Next, press the key that performs the operation you want.

To do this:	Press this key:
Return to the screen in step 6.	\leftarrow *
Store the input expression and return to the screen in step 4.	EXE or AC

* The initial value when you press this key becomes the initial value you last used for the calculation.

Important!

- Solver performs convergence a preset number of times.

If it cannot find a solution, it displays a confirmation screen like the one nearby, asking if you want to continue. Press OK while [Continue] is selected to continue or select [Exit] and then OK to cancel the Solver operation.



- Depending on what you input for the initial value for the solution variable (x in the above example), Solver may not be able to obtain a solution. If this happens, try changing the initial value so it is closer to the solution.
- Solver may not be able to determine the correct solution, even when one exists.
- Solver uses Newton's method, so even if there are multiple solutions, only one of them will be returned.
- Due to limitations in Newton's method, solutions tend to be difficult to obtain for equations like the following: $y=\sin x$, $y=e^x$, $y=\sqrt{x}$.

Inequality Calculations

You can use the Inequality app to solve a 2nd, 3rd, or 4th degree inequality.

General Procedure for Performing an Inequality Calculation

Example 1: To solve $x^2 + 2x - 3 \geq 0$

1. Press MODE , select the Inequality app icon, and then press OK .
 - This displays the number of degrees menu.

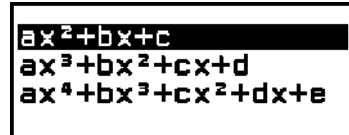

2. Select $[ax^2+bx+c]$, and then press OK .



3. On the menu that appears, select the inequality symbol type and orientation ($>$, $<$, \geq , \leq).

- Here we want to solve $x^2 + 2x - 3 \geq 0$, select $[ax^2+bx+c \geq 0]$ and then press OK .

4. On the Coefficient Editor that appears, input coefficient values.

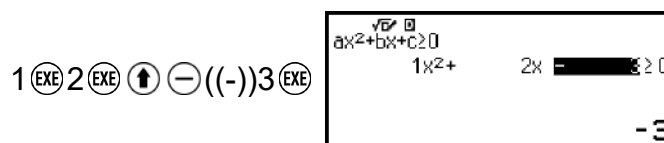

5. Press EXE .

- This will display the solution.

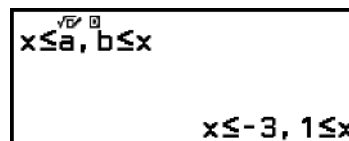

- To return to the Coefficient Editor while the solution is displayed, press \leftarrow , AC , or EXE .
- Pressing \leftarrow while the Coefficient Editor is displayed returns to the menu in step 2.
- Pressing \leftarrow while the menu in step 2 is displayed returns to the number of degrees menu.

Note

- Solutions are displayed as shown in the screen below when something other than MathI/MathO is selected for the Input/Output setting on the SETTINGS menu.



- "No Solution" appears on the solution screen when no solution exists for an inequality (such as $x^2 < 0$).
- "All Real Numbers" appears on the solution screen when the solution of an inequality is all numbers (such as $x^2 \geq 0$).

Complex Number Calculations

To perform complex number calculations, first launch the Complex app. Press \odot , select the Complex app icon, and then press OK .

Inputting Complex Numbers

You can use either rectangular coordinates ($a+bi$) or polar coordinates ($r\angle\theta$) to input complex numbers.

Example 1: To input $2+3i$

$$2 \oplus 3 \uparrow \textcircled{9} (i)^* \quad \boxed{2+3i}$$

* You can also use the following operation to input i : $\textcircled{\ominus}$ – [Complex] > [i].

Example 2: To input $5\angle 30$

$$5 \textcircled{\ominus} \text{ – [Complex] > [\angle] } 30 \quad \boxed{5\angle 30}$$

Complex App Calculation Examples

Before Performing the Example Operations

- For the examples in this section, use the SETTINGS menu to select MathI/MathO for the Input/Output setting. Configure other settings as shown for each example.
- Complex number calculation results are displayed in accordance with the Complex Result setting on the SETTINGS menu.
- If you are planning to perform input and display of the calculation result in polar coordinate format, specify the Angle Unit on the SETTINGS menu before starting the calculation.
- The θ value of the calculation result is displayed in the range of $-180^\circ < \theta \leq 180^\circ$.
- Display of the calculation result while something other than MathI/MathO is selected will show a and bi (or r and θ) on separate lines.

Example 3: $(1+i)^4 + (1-i)^2 = -4 - 2i$

(Complex Result: $a+bi$)

$$\begin{array}{l} \textcircled{(} 1 \oplus \uparrow \textcircled{9} (i) \textcircled{)} \textcircled{^} 4 \textcircled{>} \oplus \\ \textcircled{(} 1 \ominus \uparrow \textcircled{9} (i) \textcircled{)} \textcircled{^} 2 \textcircled{EXE} \end{array} \quad \boxed{\begin{array}{l} \sqrt{\textcircled{9}} \textcircled{\ominus} \quad i \quad \textcircled{\wedge} \\ (1+i)^4 + (1-i)^2 \\ -4-2i \end{array}}$$

Note

- When raising a complex number to an integer power using the syntax $(a+bi)^n$, the power value can be within the following range: $-1 \times 10^{10} < n < 1 \times 10^{10}$.

Example 4: $2\angle 45 = \sqrt{2} + \sqrt{2}i$

(Angle Unit: Degree, Complex Result: $a+bi$)

2 [Complex] > [\angle] 45 [EXE]

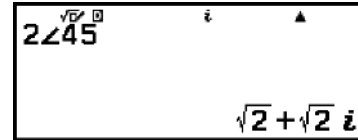

Example 5: $\sqrt{2} + \sqrt{2}i = 2\angle 45$

(Angle Unit: Degree, Complex Result: $r\angle\theta$)

$\sqrt{2}$ [Complex] + $\sqrt{2}$ [Complex] \uparrow 9 [i] [EXE]

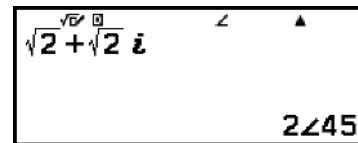

Example 6: To obtain the conjugate complex number of $2 + 3i$

(Complex Result: $a+bi$)

[Complex] > [Conjg] [Complex]
2 [Complex] + 3 [Complex] \uparrow 9 [i] [EXE]

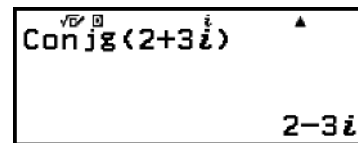

Example 7: To obtain the absolute value and argument of $1 + i$

(Angle Unit: Degree)

[Complex] > [Abs] [Complex]
1 [Complex] + [Complex] \uparrow 9 [i] [EXE]

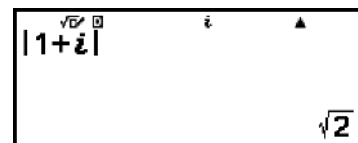

[Complex] > [Arg] [Complex]
1 [Complex] + [Complex] \uparrow 9 [i] [EXE]

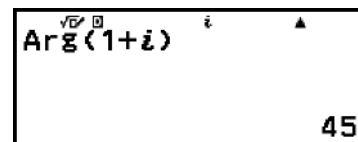

Example 8: To extract the real part and imaginary part of $2 + 3i$

[Complex] > [ReP] [Complex]
2 [Complex] + 3 [Complex] \uparrow 9 [i] [EXE]

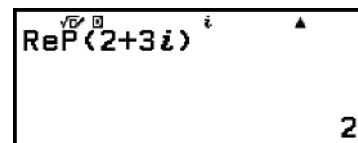

ImP – [Complex] > [Imaginary Part]
 $2 \oplus 3 \uparrow 9 (i) \text{EXE}$

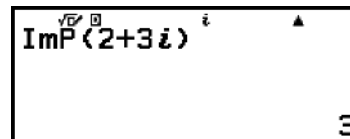

Converting a Complex Number Calculation Result to Rectangular or Polar Coordinates

You can use the FORMAT menu that appears when you press FORMAT to convert a complex number calculation result to rectangular coordinate or polar coordinate format.

Example 9: $\sqrt{2} + \sqrt{2}i = 2\angle 45$, $2\angle 45 = \sqrt{2} + \sqrt{2}i$
 (Angle Unit: Degree, Complex Result: $a+bi$)

$\sqrt{2} \oplus \sqrt{2} \uparrow 9 (i) \text{EXE}$

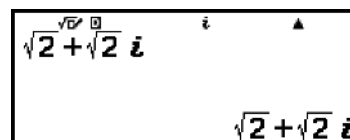

FORMAT – [Polar Coord]

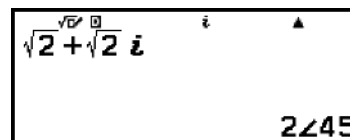

FORMAT – [Rectangular Coord]

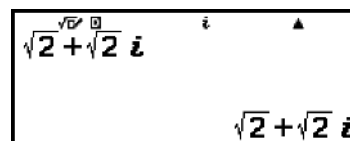

Base- n Calculations

When you want to perform calculations using decimal, hexadecimal, binary, and/or octal values, launch the Base-N app. Press Base-N , select the Base-N app icon, and then press OK . The initial default number mode setting when you launch the Base-N app is decimal.

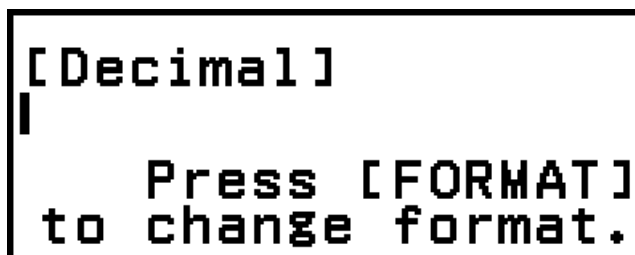

After launching the Base-N app, use FORMAT to switch number modes. Each press of FORMAT cycles through the number modes as shown below.

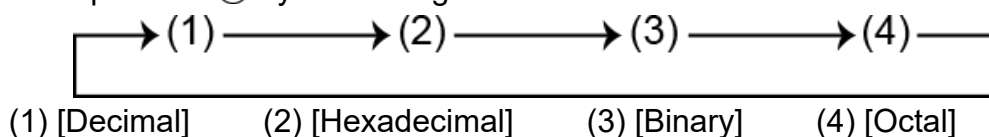

Note

- The subscripts appended to the values shown in the examples indicate the base (number mode) of each value.

Example: 1_2 ... Binary 1; 1_{16} ... Hexadecimal 1

Example 1: To calculate $11_2 + 1_2$

- Use FORMAT to change the number mode to [Binary].
- Perform the calculation $11_2 + 1_2$.

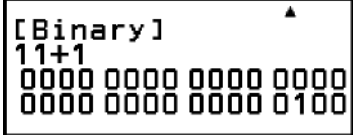
$$11 \oplus 1 \text{ EXE}$$

The calculator display shows the mode set to [Binary]. The input is 11+1, and the result is 0100.

Example 2: To calculate $1F_{16} + 1_{16}$ in hexadecimal

- Use FORMAT to change the number mode to [Hexadecimal].
- Perform the calculation $1F_{16} + 1_{16}$.

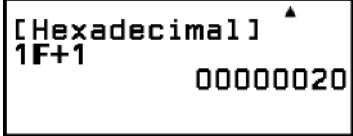
$$1 \uparrow \text{ (F) } \oplus 1 \text{ EXE}$$

The calculator display shows the mode set to [Hexadecimal]. The input is 1F+1, and the result is 00000020.

Note

- Use the following keys to input the letters A through F for hexadecimal values: \uparrow (4) (A), \uparrow (5) (B), \uparrow (6) (C), \uparrow (1) (D), \uparrow (2) (E), \uparrow (3) (F). You can also input hexadecimal values using the CATALOG menu items shown below.
 - CATALOG - [Hex Value] > [A], [B], [C], [D], [E], or [F]
- Note that if you input any character from A through F using the operation below, the character will be treated as a variable name, and not as a hexadecimal value.
 - Press VAR to display the variable list screen.
 - Select [A=], [B=], [C=], [D=], [E=], or [F=], and then press OK .
 - On the menu that appears, select [Recall].
- In the Base-N app, input of fractional (decimal) values and exponents is not supported. If a calculation result has a fractional part, it is cut off.
- Details about input and output ranges (32 bits) are shown below.

Base	Range
Binary	Positive: $00000000000000000000000000000000 \leq x \leq 01111111111111111111111111111111$ Negative: $10000000000000000000000000000000 \leq x \leq 11111111111111111111111111111111$
Octal	Positive: $0000000000 \leq x \leq 1777777777$ Negative: $2000000000 \leq x \leq 3777777777$

Decimal	$-2147483648 \leq x \leq 2147483647$
Hexadecimal	Positive: $00000000 \leq x \leq 7FFFFFFF$ Negative: $80000000 \leq x \leq FFFFFFFF$

- A Math ERROR occurs when a calculation result is outside the applicable range for the number system being used.

Specifying the Number Mode of a Particular Input Value

You can input a special command immediately before a value to specify the number mode of that value. The special commands are: d (decimal), h (hexadecimal), b (binary), and o (octal).

Example 3: To calculate $10_{10} + 10_{16} + 10_2 + 10_8$ and display the result as a decimal value

1. Use FORMA to change the number mode to [Decimal].
2. Perform the calculation $10_{10} + 10_{16} + 10_2 + 10_8$.

FORMA – [Base Prefix] > [Decimal(d)] 10 +
 FORMA – [Base Prefix] > [Hexadecimal(h)] 10 +
 FORMA – [Base Prefix] > [Binary(b)] 10 +
 FORMA – [Base Prefix] > [Octal(o)] 10 EXE

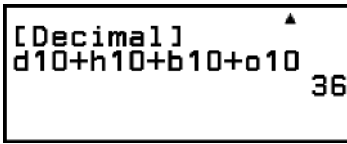

Converting a Calculation Result to Another Type of Value

You can use FORMA to convert the currently displayed calculation result to another type of value.

Example 4: To calculate $15_{10} \times 37_{10}$ in the decimal mode, and then convert the result to hexadecimal

1. Use FORMA to change the number mode to [Decimal].
2. Perform the calculation $15_{10} \times 37_{10}$.

$15 \text{ X } 37 \text{ EXE}$

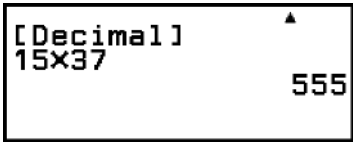

3. Use FORMA to change the number mode to [Hexadecimal].

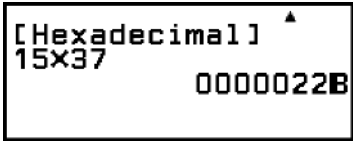

Logical and Negation Operations

Logical and negation operations are performed by pressing ☒ and selecting [Logic Operation], and then selecting the desired command (Neg, Not, and, or, xor, xnor) from the menu that appears. All of the examples below are performed in the binary mode.

Example 5: To determine the logical AND of 1010_2 and 1100_2 (1010_2 and 1100_2)

☒ – [Logic Operation] > [and]

 1010

 1100 EXE

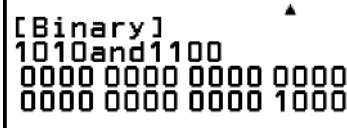

Example 6: To determine the bitwise complement of 1010_2 (Not(1010_2))

☒ – [Logic Operation] > [Not]

 1010 ☒ EXE

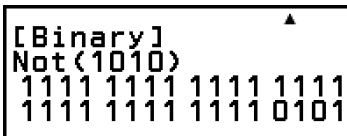

Note

- In the case of a negative binary, octal or hexadecimal value, the calculator converts the value to binary, takes the two's complement, and then converts back to the original number base. For decimal values, the calculator merely adds a minus sign.

Matrix Calculations

Use the Matrix app to perform calculations involving matrices of up to 4 rows by 4 columns.

General Procedure for Performing a Matrix Calculation

To perform a matrix calculation, use the special matrix variables (MatA, MatB, MatC, MatD) as shown in the example below.

Example 1: To calculate $\begin{bmatrix} 2 & 1 \\ 1 & 1 \end{bmatrix} \times \begin{bmatrix} 2 & -1 \\ -1 & 2 \end{bmatrix}$

- For multiplication (Matrix 1 \times Matrix 2), the number of columns in Matrix 1 must match the number of rows in Matrix 2. Otherwise, an error occurs.

1. Press ☒ , select the Matrix app icon, and then press OK .
 - This displays the matrix calculation screen.



2. Press \odot .

- This displays the matrix variable list screen.

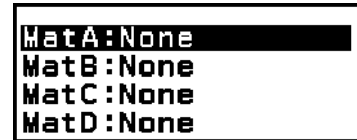

- For details about the matrix variable list screen contents, and how to perform matrix variable store, edit, or other operations, see "[Matrix Variable List Screen](#)" (page 116).

3. Perform the steps below to store $\begin{bmatrix} 2 & 1 \\ 1 & 1 \end{bmatrix}$ to MatA.

(1) Select [MatA:], and then press \odot .

- This displays the matrix size setting screen (initial default setting: 2 rows, 2 columns).

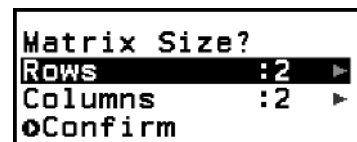

(2) Here, we want to store a 2x2 matrix, so select [Confirm] and then press \odot .

- This displays the Matrix Editor for input of the elements of the 2x2 matrix for MatA.

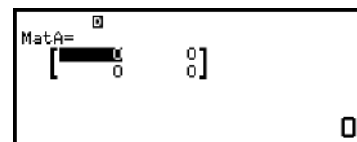

(3) Input the elements of MatA.

2 \odot 1 \odot 1 \odot 1 \odot 1 \odot

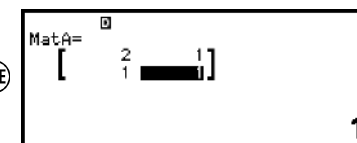

(4) Press \rightarrow , AC , or \odot to return to the matrix calculation screen.

4. Perform the steps below to store $\begin{bmatrix} 2 & -1 \\ -1 & 2 \end{bmatrix}$ to MatB.

(1) Press \odot , select [MatB:], and then press \odot .

(2) Select [Confirm], and then press \odot .

(3) Input the elements of MatB.

2 EXE \uparrow $\ominus((-)1$ EXE \uparrow $\ominus((-)1$ EXE 2 EXE

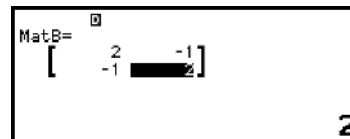

(4) Press \leftarrow , AC , or OK to return to the matrix calculation screen.

5. Input $\text{MatA} \times \text{MatB}$.

MatA \times MatB

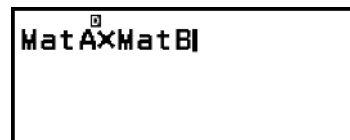

6. Press EXE .

- This displays the MatAns (Matrix Answer Memory) screen with the calculation result.

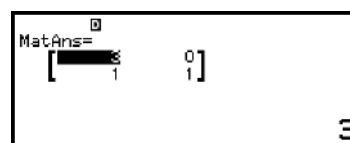

- For details about MatAns, see ["Matrix Answer Memory \(MatAns\)" \(page 119\)](#).
- Pressing AC while the MatAns screen is displayed returns to the matrix calculation screen and clears the calculation expression. Pressing \leftarrow or OK returns to the calculation expression input complete state in step 5 of this procedure.

Note

- While the Matrix Editor or the MatAns screen is displayed, you can store the currently highlighted value to a variable. While the matrix calculation screen is displayed and a calculation result value is on the screen, you can store the displayed calculation result to a variable. For details about variables, see ["Variables \(A, B, C, D, E, F, x, y, z\)" \(page 36\)](#).

Matrix Variable List Screen

The matrix variable list screen is the entry portal you should use when you want to store a matrix into matrix variable MatA, MatB, MatC, or MatD, or to edit a previously stored matrix. The status of each matrix variable is indicated as shown in the examples below.

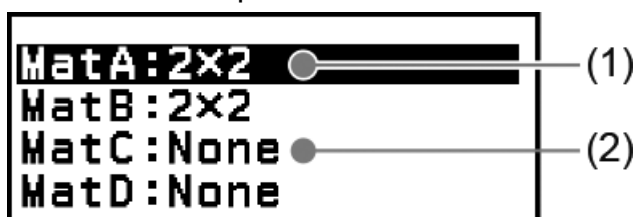

(1) 2×2

Indicates a 2×2 matrix is stored to the matrix variable.

(2) None

Indicates that nothing is stored to the matrix variable.

Displaying the matrix variable list screen

Depending on the currently displayed screen, perform one of the operations below.

- When the matrix calculation screen is displayed:
Press \odot .
- When the Matrix Editor or MatAns screen is displayed:
Press \odot , select [Define Matrix], and then press OK .

Storing New Data to a Matrix Variable

Example 2: To store the 2×3 matrix $\begin{bmatrix} 1 & 0 & -1 \\ 0 & -1 & 1 \end{bmatrix}$

1. While the matrix calculation screen is displayed, press \odot to display the matrix variable list screen.
2. Select the matrix variable (MatA, MatB, MatC, or MatD) to which you want to store new data, and then press OK .
 - If you selected a matrix variable whose status is "None", advance to step 4 of this procedure.
 - If you selected a matrix variable that already has a matrix stored to it, a menu screen will appear. Advance to step 3.



```

Edit
Define New

```

3. Select [Define New], and then press OK .
4. On the "Matrix Size?" screen that appears, specify the number of rows and columns in the matrix.

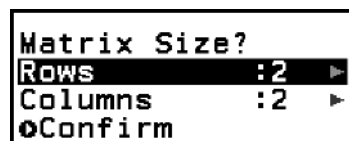

```

Matrix Size?
Rows : 2
Columns : 2
Confirm

```

- To specify a 2×3 matrix, perform the steps below.
- (1) Select [Rows] and then press OK . On the menu that appears, select [2 Rows] and then press OK .
 - (2) Select [Columns] and then press OK . On the menu that appears, select [3 Columns] and then press OK .
5. After the row and column specifications are the way you want, select [Confirm] and then press OK .
 - This displays the Matrix Editor.

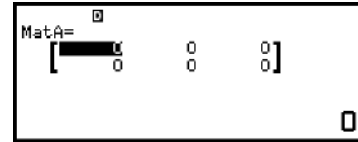

6. Input the elements of the matrix variable.

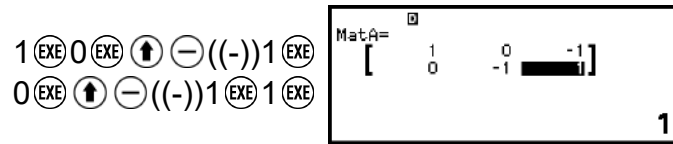

7. Press [↵], [AC], or [OK] to return to the matrix calculation screen.

Note

- Matrix variable contents are retained even if you press [↑], change the calculator app, or turn off the calculator. Executing any one of the operations below causes the contents of all matrix variables to be cleared.
 - [≡] – [Reset] > [Settings & Data]
 - [≡] – [Reset] > [Initialize All]

Editing Matrix Variable Data

1. While the matrix calculation screen is displayed, press [⏏] to display the matrix variable list screen.
2. Select the matrix variable (MatA, MatB, MatC, or MatD) you want to edit, and then press [OK].
3. On the menu that appears, select [Edit] and then press [OK].
 - This displays the Matrix Editor.
4. Use the Matrix Editor to edit the elements of the matrix.
 - Move the cursor to the cell that contains the element you want to change, input the new value, and then press [EXE].
5. Press [↵], [AC], or [OK] to return to the matrix calculation screen.

Copying Matrix Variable (or MatAns) Contents

1. Display the Matrix Editor or MatAns screen of the matrix variable you want to use as the copy source.
 - To display the Matrix Editor, perform steps 1, 2, and 3 under **"Editing Matrix Variable Data" (page 118)**.
 - To display the MatAns screen, perform the steps below while the matrix calculation screen is displayed.
 - [≡] – [Matrix] > [MatAns] [EXE]
2. Select the matrix variable copy destination.
 - For example, to copy to MatD, perform the following operation: [⏏] – [Store] > [MatD].

- This displays the Matrix Editor with the contents of the copy destination.
3. Press \leftarrow , AC , or OK to return to the matrix calculation screen.

Matrix Answer Memory (MatAns)

Whenever the result of a calculation executed in the Matrix app is a matrix, the MatAns screen will appear with the result. The result also will be stored to a variable named "MatAns".

The MatAns variable can be used in calculations as described below.

- To insert the MatAns variable into a calculation, perform the following operation: $\text{MatAns} - [\text{Matrix}] > [\text{MatAns}]$.
- Pressing any one of the following keys while the MatAns screen is displayed switches automatically to the matrix calculation screen, with "MatAns" followed by the operator or function of the key you pressed: $+$, $-$, \times , \div , $\frac{\square}{\square}$, \square^\square , \square^2 , $\sqrt{\square}$, $\sqrt[\square]{\square}$, \square^{-1} .

Note

- MatAns contents are retained even if you press OFF or turn off the calculator. Performing any one of the operations below causes the MatAns contents to be cleared.
 - Returning to the HOME screen and launching another calculator app
 - Executing $\text{MatAns} - [\text{Reset}] > [\text{Settings \& Data}]$
 - Executing $\text{MatAns} - [\text{Reset}] > [\text{Initialize All}]$

Matrix Calculation Examples

The examples below use $\text{MatA} = \begin{bmatrix} 2 & 1 \\ 1 & 1 \end{bmatrix}$, $\text{MatB} = \begin{bmatrix} 2 & 3 \\ 2 & 1 \end{bmatrix}$, $\text{MatC} =$

$$\begin{bmatrix} 1 & 0 & -1 \\ 0 & -1 & 1 \end{bmatrix}, \text{MatD} = \begin{bmatrix} 1 & 2 & 3 \\ 4 & 5 & 6 \\ 7 & 8 & 9 \end{bmatrix}.$$

Example 3: To add two matrices ($\text{MatA} + \text{MatB}$)

$$\text{MatAns} - [\text{Matrix}] > [\text{MatA}]$$

$$+ \text{MatAns} - [\text{Matrix}] > [\text{MatB}] \text{EXE}$$

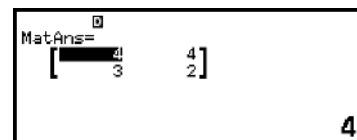

Note

- The two matrices must have the same dimensions in order to be added or subtracted. An error occurs if you try to add or subtract matrices of different dimensions.

Example 4: To square and cube MatA (MatA^2 , MatA^3)

⊖ – [Matrix] > [MatA] ⊖ – [Matrix] > [Matrix Calc] > [Matrix Squared] (EXE)

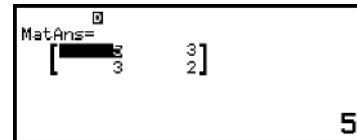

⊖ – [Matrix] > [MatA] ⊖ – [Matrix] > [Matrix Calc] > [Matrix Cubed] (EXE)

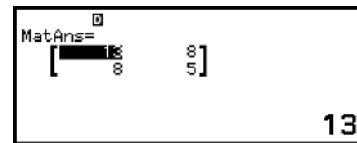

Example 5: To invert MatA (MatA^{-1})

$$[a_{11}]^{-1} = \left[\frac{1}{a_{11}} \right]$$

$$\begin{bmatrix} a_{11} & a_{12} \\ a_{21} & a_{22} \end{bmatrix}^{-1} = \frac{\begin{bmatrix} a_{22} & -a_{12} \\ -a_{21} & a_{11} \end{bmatrix}}{a_{11}a_{22} - a_{12}a_{21}}$$

$$\begin{bmatrix} a_{11} & a_{12} & a_{13} \\ a_{21} & a_{22} & a_{23} \\ a_{31} & a_{32} & a_{33} \end{bmatrix}^{-1} = \frac{\begin{bmatrix} a_{22}a_{33} - a_{23}a_{32} & -a_{12}a_{33} + a_{13}a_{32} & a_{12}a_{23} - a_{13}a_{22} \\ -a_{21}a_{33} + a_{23}a_{31} & a_{11}a_{33} - a_{13}a_{31} & -a_{11}a_{23} + a_{13}a_{21} \\ a_{21}a_{32} - a_{22}a_{31} & -a_{11}a_{32} + a_{12}a_{31} & a_{11}a_{22} - a_{12}a_{21} \end{bmatrix}}{\det \begin{bmatrix} a_{11} & a_{12} & a_{13} \\ a_{21} & a_{22} & a_{23} \\ a_{31} & a_{32} & a_{33} \end{bmatrix}}$$

⊖ – [Matrix] > [MatA] ⊖ – [Matrix] > [Matrix Calc] > [Inverse Matrix] (EXE)

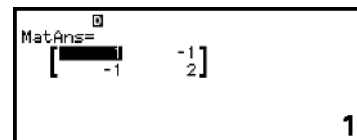

Note

- Only square matrices (same number of rows and columns) can be inverted. Trying to invert a matrix that is not square produces an error.
- A matrix with a determinant of zero cannot be inverted. Trying to invert a matrix with a determinant of zero produces an error.
- Calculation precision is affected for matrices whose determinant is near zero.

Example 6: To obtain the determinant of MatA ($\text{Det}(\text{MatA})$)

$$\det [a_{11}] = a_{11}$$

$$\det \begin{bmatrix} a_{11} & a_{12} \\ a_{21} & a_{22} \end{bmatrix} = a_{11}a_{22} - a_{12}a_{21}$$

$$\det \begin{bmatrix} a_{11} & a_{12} & a_{13} \\ a_{21} & a_{22} & a_{23} \\ a_{31} & a_{32} & a_{33} \end{bmatrix}$$

$$= a_{11}a_{22}a_{33} + a_{12}a_{23}a_{31} + a_{13}a_{21}a_{32} - a_{13}a_{22}a_{31} - a_{12}a_{21}a_{33} - a_{11}a_{23}a_{32}$$

$\text{[Matrix]} > \text{[Matrix Calc]} > \text{[Determinant]} \text{[Matrix]} > \text{[MatA]}$
 $\text{[Matrix]} > \text{[Matrix Calc]} > \text{[Matrix]} > \text{[MatA]}$

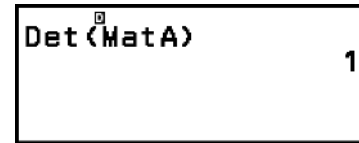

Note

- Determinants can be obtained only for square matrices (same number of rows and columns). Trying to obtain a determinant for a matrix that is not square produces an error.

Example 7: To obtain the transposition of MatC (Trn(MatC))

$\text{[Matrix]} > \text{[Matrix Calc]} > \text{[Transposition]} \text{[Matrix]} > \text{[MatC]}$
 $\text{[Matrix]} > \text{[Matrix Calc]} > \text{[Matrix]} > \text{[MatC]}$

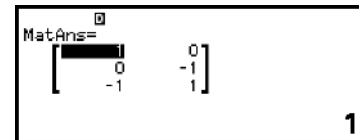

Example 8: To create a 2 × 2 identity matrix and add it to MatA (Identity(2) + MatA)

$\text{[Matrix]} > \text{[Matrix Calc]} > \text{[Identity]} \text{[Matrix]} > \text{[MatA]}$
 $\text{[Matrix]} > \text{[Matrix Calc]} > \text{[Matrix]} > \text{[MatA]}$

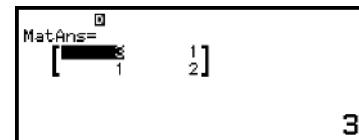

Note

- You can specify a value from 1 to 4 as the Identity command argument (number of dimensions).

Example 9: To obtain the absolute value of each element of MatC (Abs(MatC))

$\text{[Numeric Calc]} > \text{[Absolute Value]} \text{[Matrix]} > \text{[MatC]}$
 $\text{[Matrix]} > \text{[Matrix Calc]} > \text{[Matrix]} > \text{[MatC]}$

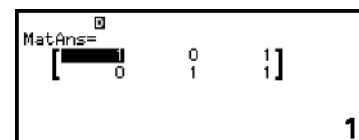

Vector Calculations

Use the Vector app to perform two-dimensional and three-dimensional vector calculations.

General Procedure for Performing a Vector Calculation

To perform a vector calculation, use the special vector variables (VctA, VctB, VctC, VctD) as shown in the example below.

Example 1: To calculate $(1, 2) + (3, 4)$

- When performing addition or subtraction of two vectors, they both must have the same dimensions.
1. Press \odot , select the Vector app icon, and then press OK .
 - This displays the vector calculation screen.

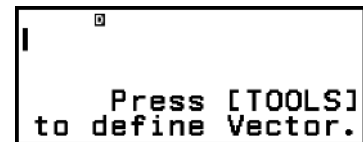

2. Press $\odot\odot\odot$.
 - This displays the vector variable list screen.

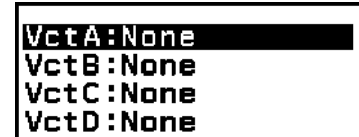

- For details about the vector variable list screen contents, and how to perform vector variable store, edit, or other operations, see "[Vector Variable List Screen](#)" (page 124).
3. Perform the steps below to store $(1, 2)$ to VctA.
 - (1) Select [VctA:], and then press OK .
 - This displays the vector dimension setting screen (initial default setting: 2 dimensions).

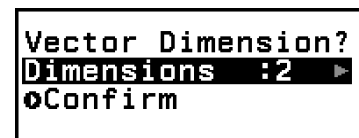

- (2) Here, we want to store a two-dimensional vector, so select [Confirm] and then press OK .
 - This displays the Vector Editor for input of the two-dimensional vector for VctA.

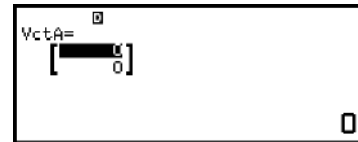

(3) Input the elements of VctA.

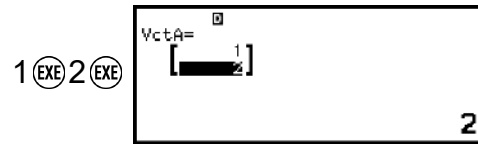

(4) Press ↵ , AC , or OK to return to the vector calculation screen.

4. Perform the steps below to store (3, 4) to VctB.

(1) Press ⏏ , select [VctB:], and then press OK .

(2) Select [Confirm], and then press OK .

(3) Input the elements of VctB.

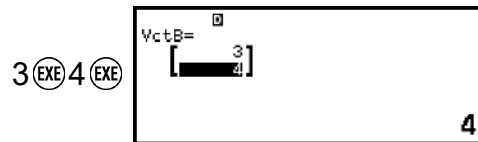

(4) Press ↵ , AC , or OK to return to the vector calculation screen.

5. Input VctA+VctB.

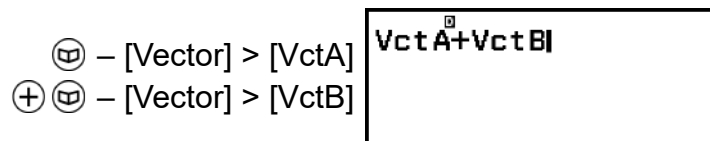

6. Press EXE .

- This displays the VctAns (Vector Answer Memory) screen with the calculation result.

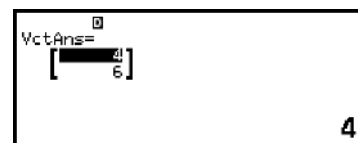

- For details about VctAns, see ["Vector Answer Memory \(VctAns\)" \(page 126\)](#).
- Pressing AC while the VctAns screen is displayed returns to the vector calculation screen and clears the calculation expression. Pressing ↵ or OK returns to the calculation expression input complete state in step 5 of this procedure.

Note

- While the Vector Editor or the VctAns screen is displayed, you can store the currently highlighted value to a variable. While the vector calculation screen is displayed and a calculation result value is on the screen, you can store the displayed calculation result

to a variable. For details about variables, see "[Variables \(A, B, C, D, E, F, x, y, z\)](#)" (page 36).

Vector Variable List Screen

The vector variable list screen is the entry portal you should use when you want to store a vector into vector variable VctA, VctB, VctC, or VctD, or to edit a previously stored vector. The status of each vector variable is indicated as shown in the examples below.

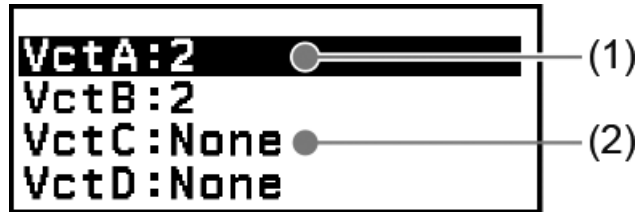

(1) 2

Indicates a two-dimensional vector is stored to the vector variable.

(2) None

Indicates that nothing is stored to the vector variable.

Displaying the vector variable list screen

Depending on the currently displayed screen, perform one of the operations below.

- When the vector calculation screen is displayed:
Press ⓪ .
- When the Vector Editor or VctAns screen is displayed:
Press ⓪ , select [Define Vector], and then press Ⓚ .

Storing New Data to a Vector Variable

Example 2: To store the three-dimensional vector (1, 2, 3)

1. While the vector calculation screen is displayed, press ⓪ to display the vector variable list screen.
2. Select the vector variable (VctA, VctB, VctC, or VctD) to which you want to store new data, and then press Ⓚ .
 - If you selected a vector variable whose status is "None", advance to step 4 of this procedure.
 - If you selected a vector variable that already has a vector stored to it, a menu screen will appear. Advance to step 3.



3. Select [Define New], and then press Ⓚ .

- On the "Vector Dimension?" screen that appears, specify the vector dimension.

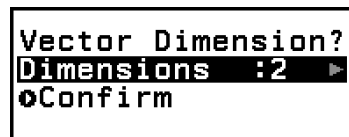

- To specify three dimensions, perform the steps below.
 - Select [Dimensions] and then press OK .
 - On the menu that appears, select [3 Dimensions] and then press OK .
- After the dimension specification is the way you want, select [Confirm] and then press OK .
 - This displays the Vector Editor.



- Input the elements of the vector variable.

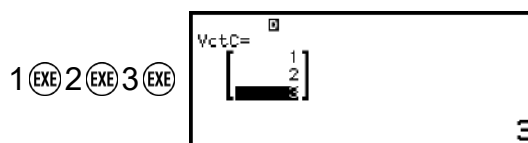

- Press Left Arrow , AC , or OK to return to the vector calculation screen.

Note

- Vector variable contents are retained even if you press Power Off , change the calculator app, or turn off the calculator. Executing any one of the operations below causes the contents of all vector variables to be cleared.
 - Menu – [Reset] > [Settings & Data]
 - Menu – [Reset] > [Initialize All]

Editing Vector Variable Data

- While the vector calculation screen is displayed, press List to display the vector variable list screen.
- Select the vector variable (VctA, VctB, VctC, or VctD) you want to edit, and then press OK .
- On the menu that appears, select [Edit] and then press OK .
 - This displays the Vector Editor.
- Use the Vector Editor to edit the elements of the vector.
 - Move the cursor to the cell that contains the element you want to change, input the new value, and then press EXE .
- Press Left Arrow , AC , or OK to return to the vector calculation screen.

Copying Vector Variable (or VctAns) Contents

1. Display the Vector Editor or VctAns screen of the vector variable you want to use as the copy source.
 - To display the Vector Editor, perform steps 1, 2, and 3 under **"Editing Vector Variable Data"** (page 125).
 - To display the VctAns screen, perform the steps below while the vector calculation screen is displayed.
 $\text{Ⓜ} - [\text{Vector}] > [\text{VctAns}] \text{Ⓜ}$
2. Select the vector variable copy destination.
 - For example, to copy to VctD, perform the following operation: $\text{Ⓜ} - [\text{Store}] > [\text{VctD}]$.
 - This displays the Vector Editor with the contents of the copy destination.
3. Press ⏪ , AC , or OK to return to the vector calculation screen.

Vector Answer Memory (VctAns)

Whenever the result of a calculation executed in the Vector app is a vector, the VctAns screen will appear with the result. The result also will be stored to a variable named "VctAns".

The VctAns variable can be used in calculations as described below.

- To insert the VctAns variable into a calculation, perform the following operation: $\text{Ⓜ} - [\text{Vector}] > [\text{VctAns}]$.
- Pressing any one of the following keys while the VctAns screen is displayed switches automatically to the vector calculation screen, with "VctAns" followed by the operator or function of the key you pressed: + , - , ⊗ , ⊘ , Ⓜ , Ⓜ^2 , Ⓜ , Ⓜ ($\sqrt{\text{Ⓜ}}$), Ⓜ (Ⓜ^{-1}).

Note

- VctAns contents are retained even if you press ⏪ or turn off the calculator. Performing any one of the operations below causes the VctAns contents to be cleared.
 - Returning to the HOME screen and launching another calculator app
 - Executing $\text{Ⓜ} - [\text{Reset}] > [\text{Settings \& Data}]$
 - Executing $\text{Ⓜ} - [\text{Reset}] > [\text{Initialize All}]$

Vector Calculation Examples

The examples below use $\text{VctA} = (1, 2)$ and $\text{VctB} = (3, 4)$, and $\text{VctC} = (2, -1, 2)$.

Example 3: $\text{VctA} \cdot \text{VctB}$ (Vector dot product)

$$(a_1, a_2) \cdot (b_1, b_2) = a_1b_1 + a_2b_2$$

$$(a_1, a_2, a_3) \cdot (b_1, b_2, b_3) = a_1b_1 + a_2b_2 + a_3b_3$$

$\text{2nd} \rightarrow [\text{Vector}] > [\text{VctA}]$
 $\text{2nd} \rightarrow [\text{Vector}] > [\text{Vector Calc}] > [\text{Dot Product}]$
 $\text{2nd} \rightarrow [\text{Vector}] > [\text{VctB}] \text{EXE}$

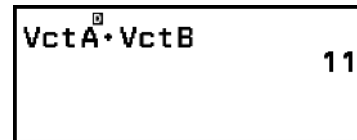

Note

- When calculating a dot product, the dimensions of the two vectors must be the same.

Example 4: VctA × VctB (Vector cross product)

$$(a_1, a_2) \times (b_1, b_2) = (0, 0, a_1b_2 - a_2b_1)$$

$$(a_1, a_2, a_3) \times (b_1, b_2, b_3)$$

$$= (a_2b_3 - a_3b_2, a_3b_1 - a_1b_3, a_1b_2 - a_2b_1)$$

$\text{2nd} \rightarrow [\text{Vector}] > [\text{VctA}]$
 $\text{2nd} \rightarrow [\text{Vector}] > [\text{Vector Calc}] > [\text{Cross Product}]$
 $\text{2nd} \rightarrow [\text{Vector}] > [\text{VctB}] \text{EXE}$

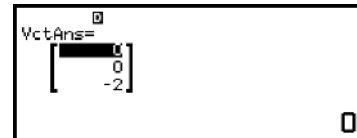

Note

- When calculating a cross product, the dimensions of the two vectors must be the same.

Example 5: To determine the angle formed by VctA and VctB to three decimal places. (Number Format: Fix 3, Angle Unit: Degree)

$\text{2nd} \rightarrow [\text{Vector}] > [\text{Vector Calc}] > [\text{Angle}]$
 $\text{2nd} \rightarrow [\text{Vector}] > [\text{VctA}]$
 $\text{↑} \text{) } (,) \text{2nd} \rightarrow [\text{Vector}] > [\text{VctB}] \text{) } \text{EXE}$

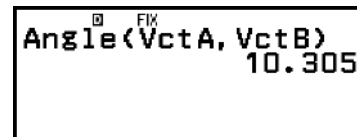

Note

- When calculating an angle formed by two vectors, the dimensions of the two vectors must be the same.

Example 6: To normalize VctB

$\text{2nd} \rightarrow [\text{Vector}] > [\text{Vector Calc}] > [\text{Unit Vector}]$
 $\text{2nd} \rightarrow [\text{Vector}] > [\text{VctB}] \text{) } \text{EXE}$

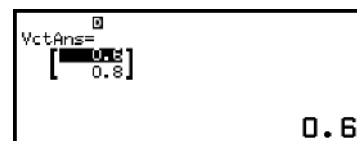

Example 7: To obtain the absolute values of VctC

$$\text{Abs}(a_1, a_2) = \sqrt{a_1^2 + a_2^2}$$

$$\text{Abs}(a_1, a_2, a_3) = \sqrt{a_1^2 + a_2^2 + a_3^2}$$

\odot – [Numeric Calc] > [Absolute Value]

\odot – [Vector] > [VctC]

) EXE



Ratio Calculations

The Ratio app lets you determine the value of X in the ratio expression A : B = X : D (or A : B = C : X) when the values of A, B, C and D are known.

General Procedure for Performing a Ratio Calculation

Example 1: To solve 3 : 8 = X : 12 for X

1. Press \odot , select the Ratio app icon, and then press OK .
2. On the menu that appears, select [A:B=X:D] or [A:B=C:X].
 - Here we want to solve 3 : 8 = X : 12 for X, select [A:B=X:D], and then press OK .
3. On the Coefficient Editor that appears, input coefficient values.
 - Here we input the following for the coefficients: A = 3, B = 8, D = 12.

3 EXE 8 EXE 12 EXE

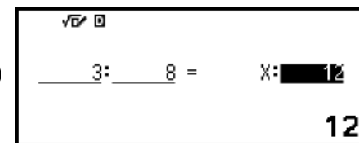

4. After all the values are the way you want, press OK .
 - This displays the solution (value of X).



- Press \odot , AC , or OK to return to the Coefficient Editor.

Note

- A Math ERROR will occur if you perform a calculation while 0 is input for a coefficient.
- Performing the steps below resets all Coefficient Editor coefficients to 1.
 - While the Coefficient Editor is displayed, press \odot , AC , \odot , or OK .
 - While a solution is displayed, press \odot or OK .
- You can store the currently displayed calculation result to a variable. For example, performing the following operation while the screen in step 4 is displayed above will store the calculation result to variable A: \odot – [A=] > [Store]. For details about variables, see "[Variables \(A, B, C, D, E, F, x, y, z\)](#)" (page 36).

To change the ratio expression type

1. While the Coefficient Editor is displayed, press \odot .
2. On the menu that appears, select the ratio expression type you want.

Calculation Example

Example 2: To calculate X in the ratio $1 : 2 = X : 10$

\odot - [Ratio] > [A:B=X:D]
 $1 \text{ [EXE]} 2 \text{ [EXE]} 10 \text{ [EXE]}$

$\sqrt{\square}$ \square
 $1 : 2 = X : 10$

\odot [EXE]

$\sqrt{\square}$ \square
 $X = 5$

Using Math Box

The Math Box app has the following learning support functions.

Dice Roll: Dice Roll is function that simulates dice probability.

Coin Toss: Coin Toss is a function that simulates coin toss probability.

Dice Roll

Dice Roll performs a simulation of one, two, or three virtual dice rolls a specified number of times. You can select either of the following screens for the result.

	A	B	C	Sum
1	1	6	4	11
2	4	3	6	13
3	3	5	1	9
4	1	6	6	13

List screen

Sum	Freq	Rel Fr	Attempts
1	46	0.184	250
2	35	0.14	
3	31	0.124	
4	39	0.156	

0.184

Relative Freq screen

Dice Roll General Operation Procedure

Example: To simulate 100 rolls of two dice. For this example, the Relative Freq screen is used for simulation results, showing the number of occurrences (frequencies) and relative frequencies of the numeric difference (0, 1, 2, 3, 4, 5) between the two dice each roll.

1. Press \odot , select the Math Box app icon, and then press OK .
 - This displays the Math Box menu.

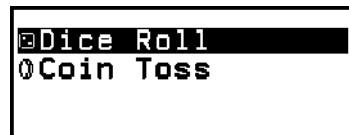

2. Select [Dice Roll], and then press OK .
 - This displays the parameter input screen.

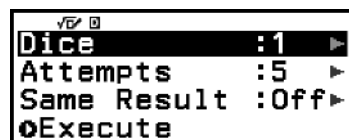

Dice: Select the number of dice as 1, 2, or 3.

Attempts: Input the number of dice rolls (number of trials) as a value from 1 to 250.

Same Result: This setting is normally Off (initial default setting). For details, see ["Same Result Setting" \(page 132\)](#).

3. Select each of the menu settings and configure them the way you want.
 - (1) Select [Dice] and then press OK . On the menu that appears, select [2 Dice] and then press OK .
 - (2) Select [Attempts] and then press OK . On the input screen that appears, input 100 and then press OK . Select [Confirm] and then press OK .
 - (3) Leave the [Same Result] set to Off (initial default setting).
4. After all of the settings are the way you want, select [Execute] and then press OK .
 - The screen showing execution of the simulation will appear, and then the screen will change to the Result Type menu.

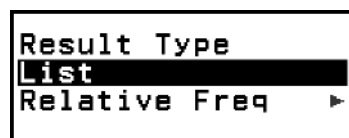

List: Shows a list of the outcome of each roll (trial).^{*1}

Relative Freq: Shows the number of occurrences based on roll results^{*2} and their relative frequencies.

- *1 When there are two dice, the outcome of each roll is displayed along with each roll's sum and difference. When there are three dice, the outcome of each roll is displayed along with the sum of the roll.
 - *2 Outcome (1 through 6) in the case of one die, sum (2 through 12) or difference (0 through 5) of the outcomes in the case of two dice, and sum (3 through 18) of the outcomes in the case of three dice.
5. Use the Result Type menu to select a result display format.
 - (1) Here, we want to display the number of occurrences and relative frequencies, so select [Relative Freq] and then press **OK**.
 - This displays the [Sum] or [Difference] selection menu.
 - (2) Here, we want to display the difference in the outcome of each roll, so select [Difference] and then press **OK**.
 - The simulation result is displayed on the Relative Freq screen.

Diff	Freq	Rel Fr	Attempts
0	14	0.14	100
1	28	0.28	
2	18	0.18	
3	21	0.21	

0.14

(The result differs with each execution.)

- For details about the simulation result screen, see **"Dice Roll Result Screen" (page 131)**.
6. To display results using a different format, display the result screen and then press **↶**.
 - This returns to the Result Type menu, so you can repeat step 5 of this procedure and change the result display format.
 7. If you want to perform a simulation with different settings, press **↶** while the Result Type menu is displayed.
 - This clears the simulation result and returns to the parameter input screen. Perform the procedure again from step 3.
 8. To exit Dice Roll, press **↶** while the parameter input screen is displayed.
 - This returns to the Math Box menu.

Note

- On the Relative Freq screen, you can store the value in a Rel Fr column cell to a variable. For example, performing the following operation in step 5, above, will store the value in the first row of the "Rel Fr" column to variable A: **↶** – [A=] > [Store]. For details about variables, see **"Variables (A, B, C, D, E, F, x, y, z)" (page 36)**.

Dice Roll Result Screen

- List screen

	A	B	Sum	Diff
1	3	6	9	3
2	5	3	8	2
3	6	3	9	3
4	2	2	4	0

- (1) Each row shows a sequential roll number. For example, 1 is the first roll, 2 is the second roll, and so on.
- (2) A, B, and C indicate each of the die being used. "Sum" is for the outcome total, and "Diff" is for the difference between the outcomes of two dice. The columns that appear on the display depend on how many dice are being used.
 - 1 die: A-column only.
 - 2 dice: A, B, Sum, and Diff columns.
 - 3 dice: A, B, C, and Sum columns.

• Relative Freq screen

Sum	Freq	Rel Fr
1	46	0.184
2	35	0.14
3	31	0.124
4	39	0.156

Attempts: 250

0.184

- (1) Sum or Diff: Shows the one die outcome (Sum: 1 through 6), two dice outcome sum (Sum: 2 through 12) or difference (Diff: 0 through 5), or three dice outcome sum (Sum: 3 through 18).
- (2) Freq: Shows the number of occurrences (frequency) of each roll outcome.
- (3) Rel Fr: Shows the relative frequency (frequency divided by number of rolls) of roll results.
- (4) Number of trials
- (5) Highlighted Rel Fr cell's value

Same Result Setting

When executing a Dice Roll or Coin Toss simulation with Same Result at its initial default setting (Off), each execution displays a different (random) result. If the Same Result setting is changed to something other than Off, the displayed results are those determined by the calculator. Using the #1, #2, or #3 setting is useful when you want the same result to be displayed by all the calculators being used by the students in a class.

Note

- To have multiple calculators display the same result, make sure that the settings below are identical on all of the calculators.
 - Number of dice or coins
 - Number of trials (rolls or tosses)
 - Same Result setting (#1, #2, or #3)

Coin Toss

Coin Toss performs a simulation of one, two, or three virtual coin tosses a specified number of times. You can select either of the following screens for the result.

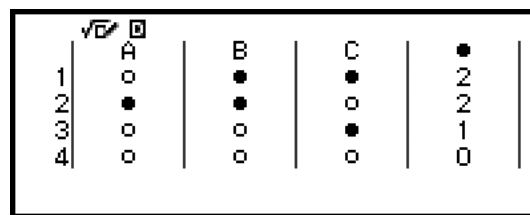

	A	B	C	●
1	○	●	●	2
2	●	●	○	2
3	○	○	●	1
4	○	○	○	0

List screen

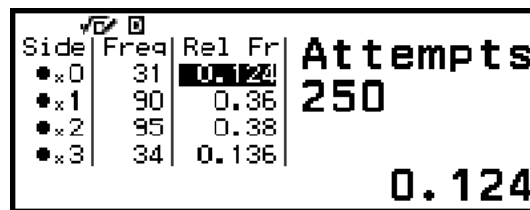

Side	Freq	Rel Fr	Attempts
●×0	31	0.124	250
●×1	90	0.36	
●×2	95	0.38	
●×3	34	0.136	

0.124

Relative Freq screen

The screen shows heads as ● and tails as ○.

Coin Toss General Operation Procedure

Example: To simulate 100 tosses of three coins. For this example, the Relative Freq screen is used for simulation results, showing the number of heads (0, 1, 2, 3) and the relative frequencies of heads of each toss.

1. Press \odot , select the Math Box app icon, and then press OK .
 - This displays the Math Box menu.

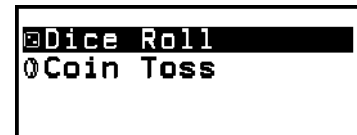

2. Select [Coin Toss], and then press OK .
 - This displays the parameter input screen.

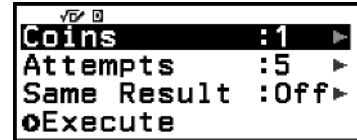

Coins: Select the number of coins as 1, 2, or 3.

Attempts: Input the number of coin tosses (number of trials) as a value from 1 to 250.

Same Result: This setting is normally Off (initial default setting). For details, see ["Same Result Setting" \(page 132\)](#).

3. Select each of the menu settings and configure them the way you want.
 - (1) Select [Coins] and then press **OK**. On the menu that appears, select [3 Coins] and then press **OK**.
 - (2) Select [Attempts] and then press **OK**. When the input screen appears, input 100 and then press **OK**. Select [Confirm] and then press **OK**.
 - (3) Leave the [Same Result] set to Off (initial default setting).
4. After all of the settings are the way you want, select [Execute] and then press **OK**.
 - The screen showing execution of the simulation will appear, and then the screen will change to the Result Type menu.

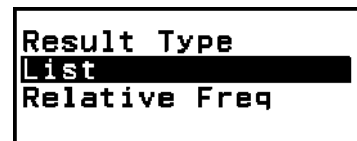

List: Shows a list of heads or tails*¹ for each toss (trial).

Relative Freq: Shows the number of occurrences for each coin that comes up heads,*² and their relative frequencies.

*¹ When there are two or three coins, shows the number of coins of each toss that come up heads.

*² For two or three coins. When there is one coin, this shows the frequencies of heads and tails and the relative frequencies.

5. Use the Result Type menu to select a result display format. Here we want to display the number of occurrences and relative frequencies, so select [Relative Freq] and then press **OK**.
 - The simulation result is shown on the Relative Freq screen.

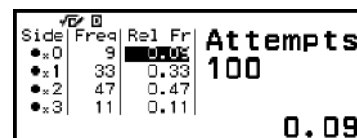

(The result differs with each execution.)

- For details about the simulation result screen, see ["Coin Toss Result Screen" \(page 135\)](#).

6. To display results using a different format, display the result screen and then press \odot .
 - This returns to the Result Type menu, so you can repeat step 5 of this procedure and change the result display format.
7. If you want to perform a simulation with different settings, press \odot while the Result Type menu is displayed.
 - This clears the simulation result and returns to the parameter input screen. Perform the procedure again from step 3.
8. To exit Coin Toss, press \odot while the parameter input screen is displayed.
 - This returns to the Math Box menu.

Note

- On the Relative Freq screen, you can store the value in a Rel Fr column cell to a variable. For example, performing the following operation in step 5, above, will store the value in the first row of the "Rel Fr" column to variable A: \odot - [A=] > [Store].

Coin Toss Result Screen

- List screen

	A	B	C	●
1	○	●	●	2
2	●	●	○	2
3	○	○	●	1
4	○	○	○	0

- (1) Each row shows a sequential toss number. For example, 1 is the first toss, 2 is the second toss, and so on.
- (2) A, B, and C indicate each of the coins being used. When two coins or three coins are being used, the ● column on the right shows the number of coins that came up heads.

- Relative Freq screen

Side	Freq	Rel Fr
●x0	31	0.124
●x1	90	0.36
●x2	95	0.38
●x3	34	0.136

Attempts 250

0.124

- (1) Side: When using only one coin, "●" indicates heads while "○" indicates tails. When using two or three coins, this column shows the number of heads (0 to 3).
- (2) Freq: Shows the number of occurrences (frequency) of each toss outcome.
- (3) Rel Fr: Shows the relative frequency (frequency divided by number of tosses) of toss results.
- (4) Number of trials
- (5) Highlighted Rel Fr cell's value

Technical Information

Errors

The calculator will display an error message whenever an error occurs for any reason during a calculation.

Displaying the Location of an Error

While an error message is displayed, pressing OK , ↵ , or AC returns to the screen that was displayed immediately before the error message appeared. The cursor will be positioned at the location where the error occurred, ready for input. Make the necessary corrections to the calculation and execute it again.

Example: When you input $14 \div 0 \times 2$ by mistake instead of $14 \div 10 \times 2$.

14 \div 0 \times 2 EXE

Math ERROR
Back

OK (or ↵ or AC)

14 \div 0 \times 2

\leftarrow 1 EXE

14 \div 10 \times 2
14
5

Error Messages

Syntax ERROR

Cause:

- There is a problem with the format of the calculation you are performing.

Action:

- Make necessary corrections.

Math ERROR

Cause:

- The intermediate or final result of the calculation you are performing exceeds the allowable calculation range.

- Your input exceeds the allowable input range (particularly when using functions).
- The calculation you are performing contains an illegal mathematical operation (such as division by zero).
- While using an app that does not support complex numbers or while a screen that does not accept input of complex numbers is displayed, you attempted to execute a calculation that includes a variable where a complex number is stored.

Action:

- Check the input values, reduce the number of digits, and try again.
 - When using a variable as the argument of a function, make sure that the variable value is within the allowable range for the function.
 - To execute a calculation that includes a variable where a complex number is stored, while using an app that does not support complex numbers or while a screen that does not accept input of complex numbers is displayed, change the value stored to the variable to a real number.
-

Stack ERROR

Cause:

- The calculation you are performing has caused the capacity of the numeric stack or the command stack to be exceeded.
- The calculation you are performing has caused the capacity of the matrix or vector stack to be exceeded.

Action:

- Simplify the calculation expression so it does not exceed the capacity of the stack.
 - Try splitting the calculation into two or more parts.
-

Argument ERROR

Cause:

- There is a problem with the argument of the calculation you are performing.

Action:

- Make necessary corrections.
-

Dimension ERROR (Matrix and Vector apps only)

Cause:

- You are trying to perform a calculation with matrices or vectors whose dimensions do not allow that type of calculation.

Action:

- Check the dimensions specified for the matrices or vectors to see if they are compatible with the calculation.

Variable ERROR (Equation app's Solver feature only)**Cause:**

- An attempt to execute Solver for an expression input without any variable included.

Action:

- Input an expression that includes a variable.

Cannot Solve (Equation app's Solver feature only)**Cause:**

- The calculator could not obtain a solution.

Action:

- Check for errors in the equation that you input.
- Input a value for the solution variable that is close to the expected solution and try again.

Range ERROR**Cause (Table app):**

- An attempt to generate a number table in the Table app whose conditions cause it to exceed the maximum number of allowable rows.

Action:

- Narrow the table calculation range by changing the Start, End, and Step values, and try again.

Cause (Spreadsheet app):

- During batch input in the Spreadsheet app, input for Range is outside the allowable range or is a cell name that does not exist.

Action:

- For Range, input a cell name within the range of A1 through E45, using the syntax: "A1:A1".

Cause (Math Box app):

- The value input as the Attempts (number of trials) for Dice Roll or Coin Toss is outside the allowable range or is a non-integer value.

Action:

- For Attempts, input an integer value that is within the allowable range.
-

Time Out

Cause (differential or integration calculation):

- The current differential or integration calculation ends without the ending condition being fulfilled.

Action:

- Try increasing the *tol* value. Note that this also decreases solution precision.

Cause (Distribution app):

- The current distribution calculation ends without the ending condition being fulfilled.

Action:

- Change the value of each parameter.
-

Circular ERROR

Cause ($f(x)$ and $g(x)$ feature):

- Circular reference is occurring in a registered composite function (["Registering a Composite Function" \(page 62\)](#)).

Action:

- Do not have $g(x)$ input into $f(x)$, and $f(x)$ input into $g(x)$ at the same time.

Cause (Spreadsheet app):

- There is a circular reference (such as "=A1" in cell A1) in the spreadsheet.

Action:

- Change cell contents to remove the circular references.
-

Memory ERROR (Spreadsheet app only)

Cause:

- You are attempting to input data that exceeds the allowable input capacity (1,700 bytes).
- You are attempting to input data that results in a chain of consecutive cell references (such as cell A2 referenced from cell A1, cell A3 referenced from cell A2..., etc.) This type of input always causes this error to be generated, even if memory capacity (1,700 bytes) is not exceeded.

Action:

- Delete unneeded data and input data again.
 - Minimize input that results in a chain of consecutive cell references.
-

Not Defined

Cause ($f(x)$ and $g(x)$ feature):

- You attempted to calculate $f(x)$ or $g(x)$ with $f(x)/g(x)$ undefined.

Action:

- Define $f(x)$ or $g(x)$ before calculating $f(x)/g(x)$.

Cause (Matrix and Vector apps):

- The matrix or vector you are trying to use in a calculation was input without specifying its dimension.

Action:

- Specify the dimension of the matrix or vector and then perform the calculation again.

Before Assuming Malfunction of the Calculator...

Note that you should make separate copies of important data before performing these steps.

1. Check the calculation expression to make sure that it does not contain any errors.
2. Make sure that you are using the correct calculator app for the type of calculation you are trying to perform.
 - To check which calculator app you are currently using, press \odot . This highlights the icon of the calculator app currently in use.
3. If the above steps do not correct your problem, press the \downarrow key.
 - This causes the calculator to perform a routine that checks whether calculation functions are operating correctly. If the calculator discovers any abnormality, it automatically initializes the calculator app and clears memory contents.
4. Return the calculator settings (except for Contrast and Auto Power Off) to their initial default settings by performing the procedure below.
 - (1) Press \odot , select a calculator app icon, and then press OK .
 - (2) Press \equiv , and then select [Reset] > [Settings & Data] > [Yes].

Replacing the Battery

If the screen shown below appears right after you turn on power, it means that remaining battery power is low.

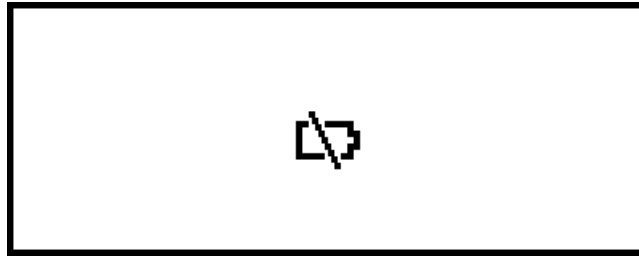

A low battery is also indicated by a dim display, even if contrast is adjusted, or by failure of figures to appear on the display immediately after you turn on the calculator.

If this happens or the above screen appears, replace the battery with a new one.

Important!

- Removing the battery causes all of the calculator's memory contents to be cleared.

1. Press \uparrow (AC) (OFF) to turn off the calculator.
 - To ensure that you do not accidentally turn on power while replacing the battery, attach the front cover to the front of the calculator.
2. As shown in the illustration, remove the battery cover, remove the battery, and then load a new battery with its plus (+) and minus (-) ends facing correctly.

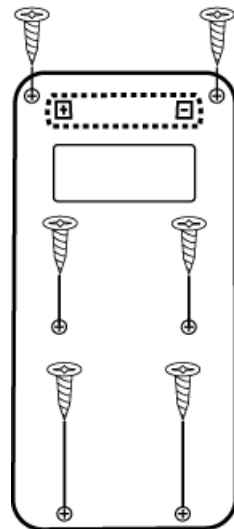

fx-570CW

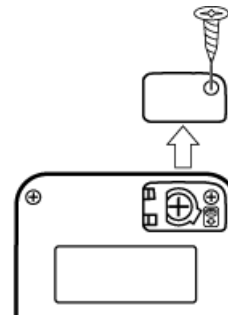

fx-991CW

3. Replace the battery cover.
4. Press \odot to turn on the calculator.
5. Initialize the calculator.
 - (1) Press \odot , select a calculator app icon, and then press OK .
 - (2) Press ≡ , and then select [Reset] > [Initialize All] > [Yes].
 - Do not skip the above steps!

Calculation Priority Sequence

The calculator performs calculations according to a calculation priority sequence.

- Basically, calculations are performed from left to right.
- Expressions within parentheses have the highest priority.
- The following shows the priority sequence for each individual command.

1	Parenthetical expressions
2	Functions that have parentheses (sin(, log(, f(, g(, etc., functions that take an argument to the right, functions that require a closing parenthesis after the argument)
3	Functions that come after the input value (x^2 , x^3 , x^{-1} , $x!$, $^{\circ}$, $^{\circ}$, $^{\circ}$, $^{\circ}$, $^{\circ}$, $^{\circ}$), engineering symbols (m, μ , n, p, f, k, M, G, T, P, E), powers (x^{\blacksquare}), roots ($\sqrt{\blacksquare}$)
4	Fractions
5	Negative sign ((-)), Base Prefix (d, h, b, o)
6	Unit conversion commands (cm \blacktriangleright in, etc.), Statistics app estimated values (\hat{x} , \hat{y} , \hat{x}_1 , \hat{x}_2)
7	Multiplication where the multiplication sign is omitted
8	Permutation (nPr), combination (nCr), complex number polar coordinate symbol (\angle)
9	Dot product (\bullet)
10	Multiplication (\times), division (\div)
11	Addition (+), subtraction (-)
12	and (logical operator)
13	or, xor, xnor (logical operators)

If a calculation contains a negative value, you may need to enclose the negative value in parentheses. If you want to square the value -2, for example, you need to input: $(-2)^2$. This is because x^2 is a function

preceded by a value (Priority 3, above), whose priority is greater than the negative sign, which is a prefix symbol (Priority 5).

Example:

\ominus $((-))$ 2 \square^2 EXE $-2^2 = -4$
 \ominus $((-))$ 2 $\text{)} \square^2 \text{EXE}$ $(-2)^2 = 4$

Calculation Ranges, Number of Digits, and Precision

The calculation range, number of digits used for internal calculation, and calculation precision depend on the type of calculation you are performing.

Calculation Range and Precision

Calculation Range	$\pm 1 \times 10^{-99}$ to $\pm 9.999999999 \times 10^{99}$ or 0
Number of Digits for Internal Calculation	23 digits
Precision	In general, ± 1 at the 10th digit for a single calculation. Precision for exponential display is ± 1 at the least significant digit. Errors are cumulative in the case of consecutive calculations.

Function Calculation Input Ranges and Precision

Functions	Input Range	
sinx cosx	Degree	$0 \leq x < 9 \times 10^9$
	Radian	$0 \leq x < 157079632.7$
	Gradian	$0 \leq x < 1 \times 10^{10}$

tan x	Degree	Same as sin x, except when $ x = (2n - 1) \times 90$.
	Radian	Same as sin x, except when $ x = (2n - 1) \times \pi/2$.
	Gradian	Same as sin x, except when $ x = (2n - 1) \times 100$.
$\sin^{-1}x, \cos^{-1}x$	$0 \leq x \leq 1$	
$\tan^{-1}x$	$0 \leq x \leq 9.999999999 \times 10^{99}$	
$\sinh x, \cosh x$	$0 \leq x \leq 230.2585092$	
$\sinh^{-1}x$	$0 \leq x \leq 4.999999999 \times 10^{99}$	
$\cosh^{-1}x$	$1 \leq x \leq 4.999999999 \times 10^{99}$	
$\tanh x$	$0 \leq x \leq 9.999999999 \times 10^{99}$	
$\tanh^{-1}x$	$0 \leq x \leq 9.999999999 \times 10^{-1}$	
$\log x, \ln x$	$0 < x \leq 9.999999999 \times 10^{99}$	
10^x	$-9.999999999 \times 10^{99} \leq x \leq 99.99999999$	
\sqrt{x}	$0 \leq x < 1 \times 10^{100}$	
x^2	$ x < 1 \times 10^{50}$	
x^{-1}	$ x < 1 \times 10^{100}; x \neq 0$	
$x!$	$0 \leq x \leq 69$ (x is an integer)	
nPr	$0 \leq n < 1 \times 10^{10}, 0 \leq r \leq n$ (n, r are integers) $1 \leq \{n!/(n-r)!\} < 1 \times 10^{100}$	
nCr	$0 \leq n < 1 \times 10^{10}, 0 \leq r \leq n$ (n, r are integers) $1 \leq n!/r! < 1 \times 10^{100}$ or $1 \leq n!/(n-r)! < 1 \times 10^{100}$	
$\text{Pol}(x, y)$	$ x , y \leq 9.999999999 \times 10^{99}$ $\sqrt{x^2 + y^2} \leq 9.999999999 \times 10^{99}$	
$\text{Rec}(r, \theta)$	$0 \leq r \leq 9.999999999 \times 10^{99}$ θ : Same as sin x	

$a^{\circ}b'c''$	$ a , b, c < 1 \times 10^{100}; 0 \leq b, c$ The display seconds value is subject to an error of ± 1 at the second decimal place.
$a^{\circ}b'c'' = x$	$0^{\circ}0'0'' \leq x \leq 99999999^{\circ}59'59''$ A sexagesimal value outside of the above range is automatically treated as a decimal value.
x^y	$x > 0: -1 \times 10^{100} < y \log x < 100$ $x = 0: y > 0$ $x < 0: y = n, \frac{m}{2n+1}$ (m, n are integers) However: $-1 \times 10^{100} < y \log x < 100$
$\sqrt[x]{y}$	$y > 0: x \neq 0, -1 \times 10^{100} < 1/x \log y < 100$ $y = 0: x > 0$ $y < 0: x = 2n+1, \frac{2n+1}{m}$ ($m \neq 0; m, n$ are integers) However: $-1 \times 10^{100} < 1/x \log y < 100$
$a^{b/c}$	Total of integer, numerator, and denominator must be 10 digits or less (including separator symbol).
RanInt#(a, b)	$a < b; a , b < 1 \times 10^{10}; b - a < 1 \times 10^{10}$

- Precision is basically the same as that described under "Calculation Range and Precision", above.
- $x^y, \sqrt[x]{y}, x!, nPr, nCr$ type functions require consecutive internal calculation, which can cause accumulation of errors that occur with each calculation.
- Error is cumulative and tends to be large in the vicinity of a function's singular point and inflection point.
- The range for calculation results that can be displayed in π form when MathI/MathO is selected for Input/Output on the SETTINGS menu is $|x| < 10^6$. Note, however, that internal calculation error can make it impossible to display some calculation results in π form. It also can cause calculation results that should be in decimal form to appear in π form.

Specifications

fx-570CW

Power Requirements:

AAA-size battery R03 × 1

Approximate Battery Life:

2 years (based on one hour of operation per day)

Power Consumption:

0.0008 W

Operating Temperature:

0°C to 40°C (32°F to 104°F)

Dimensions:

13.8 (H) × 77 (W) × 162 (D) mm

$\frac{9}{16}$ " (H) × $3\frac{1}{16}$ " (W) × $6\frac{3}{8}$ " (D)

Approximate Weight:

100 g (3.5 oz) including the battery

fx-991CW

Power Requirements:

Built-in solar cell; button battery LR44 × 1

Approximate Battery Life:

2 years (based on one hour of operation per day)

Operating Temperature:

0°C to 40°C (32°F to 104°F)

Dimensions:

10.7 (H) × 77 (W) × 162 (D) mm

$\frac{7}{16}$ " (H) × $3\frac{1}{16}$ " (W) × $6\frac{3}{8}$ " (D)

Approximate Weight:

95 g (3.4 oz) including the battery

Frequently Asked Questions

Frequently Asked Questions

■ How can I change a fraction form result produced by a division operation to decimal form?

→ While a fraction calculation result is displayed, press FORMAT and then select [Decimal], or press EXE (\approx). To have calculation results initially appear as decimal values, change the Input/Output setting on the SETTINGS menu to MathI/DecimalO.

■ What is the difference between Ans memory and variable memory?

→ Each of these types of memory acts like "containers" for temporary storage of a single value.

Ans Memory: Stores the result of the last calculation performed. Use this memory to carry the result of one calculation on to the next.

Variables: This memory is helpful when you need to use the same value multiple times in one or more calculations.

■ How can I find a function I was using with an older CASIO calculator model on this calculator?

→ This calculator's functions can be accessed from the CATALOG menu that appears when you press CATALOG . For details, see the sections below.

["Using the CATALOG Menu" \(page 25\)](#)

["Advanced Calculations" \(page 46\)](#)

■ With an older CASIO calculator model, I pressed S+D to change the calculation result display format. What should I do with this calculator?

→ While a calculation result is displayed, press FORMAT . Use the menu that appears to select the display format you want. For details, see

["Changing Calculation Result Format" \(page 39\)](#).

■ How can I find out which calculator app I am currently using?

→ Press HOME . This causes the icon of the calculator app you are currently using to become highlighted.

■ How do I calculate $\sin^2 x$

→ For example, to calculate $\sin^2 30 = \frac{1}{4}$, enter the calculation below.

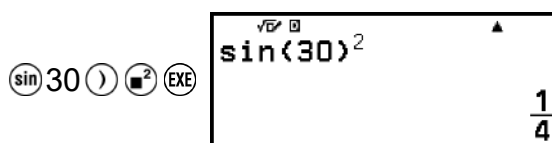

■ **Why can't I input i or calculate a complex number?**

→ You cannot use the Calculate app to input i or to perform complex number calculations. Use the Complex app for such calculations.

■ **Why does the battery icon (🔋) appear right after the calculator is turned on?**

→ The battery icon indicates that battery power is low. If you see this icon, replace the battery as soon as possible. For details about battery replacement, see ["Replacing the Battery" \(page 141\)](#).

■ **How can I return the calculator to its initial default settings?**

→ Perform the procedure below to initialize calculator settings (except for Contrast and Auto Power Off).

(1) Press \odot , select a calculator app icon, and then press OK .

(2) Press \equiv , and then select [Reset] > [Settings & Data] > [Yes].

CASIO®

SA2207-A

© 2022 CASIO COMPUTER CO., LTD.